

Suspension Bridges

(Hänge- und Spannbandbrücken)

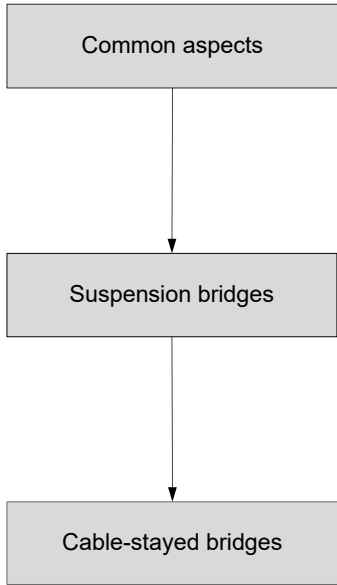

Overview
(types of suspension bridges)

stress-ribbons
(suspended bridges)

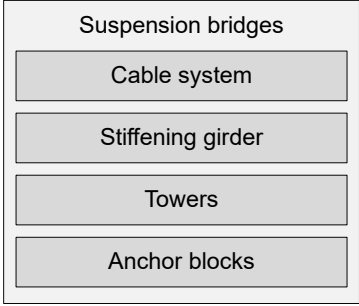

Suspension Bridges

Overview

Suspension Bridges – Overview

- Bridges carrying loads primarily by funicular action of cables can be categorised as follows:
 - Suspension bridges: Strongly sagging main cables spanning between towers. Cables loaded laterally by vertical hangers connecting the suspended deck girder to the main cables.
 - Suspended bridges / stress-ribbons: Slightly sagging main cables, spanning between abutments without towers. Cables loaded laterally by the deck girder. The deck follows the cable profile in elevation.
- Suspended bridges are commonly referred to as stress-ribbons if the deck consists of a prestressed concrete slab. However, the term “stress-ribbon” is also used for other types of suspended bridges.
- The typical spans of suspension bridges and suspended bridges / stress-ribbons differ by an order of magnitude.

Suspension bridge
(Hängebrücke)

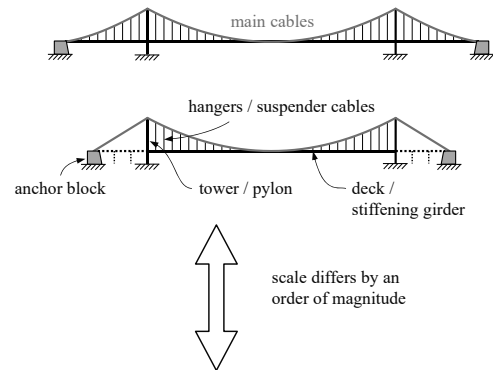

Suspended bridge / Stress-ribbon
(Spannband)



Suspension Bridges – Overview

- Suspended bridges without any stiffening girder were presumably among the first bridges mankind used.
- The stiffness of such bridges essentially corresponds to that of the main cables:
 - very flexible structures under non-funicular loads (see section *static analysis of cables*)
 - range of application very limited: Trails, pedestrian bridges with alternative routes (wheelchairs), etc.
- Suspended bridges are very efficient, and can be designed and built with moderate technical know-how unless spans are very long (such as in the Randa bridge designed by Theo Lauber, with a span of 494 m, equipped with special damping devices).
- Such bridges have recently gained popularity in Switzerland, partly for access in mountain areas, partly as mere tourist attractions.
- Many of these bridges are designed following design guidelines established by Helvetas more than 50 years ago, see next slide.



Suspended bridge in Nepal. Photo: Helvetas (www.helvetas.org)

Charles Kuonen Bridge, Randa, Switzerland, Theo Lauber / Swissrope (Lauber Seilbahnen) Frutigen, 2017. Suspended trail bridge, span 494 m, 85 m above ground, deck width 0.65 m. Photo Schweizer Wanderwege, wander.ch

Suspension Bridges – Overview

- Helvetas launched first projects for erecting trail bridges in Nepal in 1956. Since then, more than 7'000 trail bridges have been built, with suspended bridges up to spans of 156 m, and suspension bridges up to 355 m (see notes for details).
- Today, activities range from advising the government on its vocational training and trail bridge programs to practical activities reducing communities' vulnerability to disasters.
- For more information on the Helvetas trail bridge programme see www.helvetas.org.



12.05.2023

ETH Zürich | Chair of Concrete Structures and Bridge Design | Bridge Design Lectures

6

First edition of Design Guidelines, edited by Helvetas Trail Bridge Section, Nepal:

J. Kraehenbuehl, D. Panciotto, C.B. Basnet, A. Wagner, A. Grob, H.P. Maag. Survey, design and construction of trail suspension bridges for remote areas (Vol. A Design. Vol. B Survey. Vol. C, part 1 and 2 Standard design drawings. Vol. D Costing and contracting). SKAT, Swiss Center for Appropriate Technology, 1983.

Current editions (<http://nepaltrailbridges.org.np/manuals>):

Nepal, Department of Local Infrastructure Development and Agricultural Roads, Trail Bridge Section / Helvetas Nepal, Swiss Centre for Development Cooperation in Technology and Management, Helvetas: Short Span Trail Bridge Standard, 2003:

1. Short Span Trail Bridge Standard – Technical Handbook: How to Build a Short Span Trail Suspended Bridge
2. Short Span Trail Bridge Standard – Technical Handbook: How to Build a Short Span Trail Suspension Bridge
3. Long Span Trail Bridge Standard – Technical Handbook

Photo Credits: Helvetas (www.helvetas.org)

See also <http://sbd.gov.np/page/detail/about-sbd> (April 2020).

Suspension Bridges – Overview

- The span range of suspended bridges is limited, among other reasons by aerodynamic stability (overturning of “deck”, as e.g. occurred in the first Trift trail bridge in Switzerland).
- For longer spans, suspension footbridges are used, both in Nepal and in Switzerland. Some of them are spectacular, such as the Panoramabrücke Sigriswil with a span of 344 m, 85 m above ground (Martin Dietrich, Theiler Ingenieure).

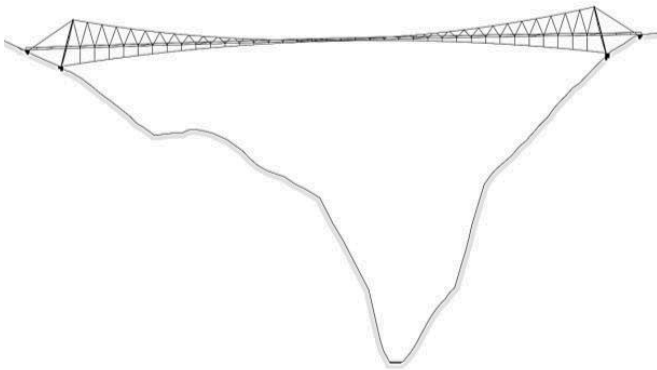

Panoramabrücke Sigriswil, Thunersee Rundweg, Switzerland, Martin Dietrich / Theiler Ingenieure, 2012. Suspension footbridge, span 344 m, 182 m above Gummischlucht, deck width 1.20 m. Photos: <https://www.atu-prix.ch/de/archiv/auszeichnungen/panoramabruecke-sigriswil/>

Suspension Bridges – Overview

- The focus of the lecture is, however, on suspension bridges carrying road and/or rail traffic (upper photo).
- Some peculiarities of stress-ribbon bridges are also discussed (lower photo).
- Suspended bridges and suspension footbridges are not treated in more detail in the lecture.
- In the last decades, cable-stayed solutions have been preferred in many bridges where suspension bridges could have been a viable alternative. Apart from the advantages of cable-stayed bridges related to the construction process (see respective slides), this can be attributed to
 - ... material cost: as shown by Leonhardt (see notes), much higher quantities (cables) are used for suspension bridges
 - ... the high cost of the anchorages of suspension bridges, which may exceed 25% of the total bridge cost (source see notes).



Akashi-Kaikyo Bridge, Akashi Strait, Japan, Satoshi Kashima / Japan Bridge Engineering Centre, 1998. Main span 1990 m (1992 m since Kobe Earthquake), current record span (until 2022/23).

Photo: <https://somejapan.com/maikos-akashi-kaikyo-bridge-the-longest-suspension-bridge-in-the-world/>

Prague-Troja stress-ribbon footbridge, Jiri Staasky, 1984. stress-ribbon, main span 96 m, sag 1.69 m, total length 261 m. Collapsed on 2.12.2017, presumably due to corrosion.

Photo: <http://www.shp.eu/en/strasky-husty-a-partneri/projects/bridges/pedestrian-bridges/stress-ribbon-bridges/ds-l-bridges/>

Reference for cable cost: Leonhardt, F., Cable-stayed bridges for long spans, BBR Australia Pty Ltd, 1978.

Reference for anchorage cost: Personal exchange with David Goodyear.

Suspension Bridges

Cable system

Suspension Bridges – Cable system

- Many cable layouts are possible, whose suitability depends on the specific site. Preferences of clients and designers are also important due to the high visual impact of long-span bridges.
- The figure schematically shows a selection of common solutions, which differ mainly in the following aspects:
 - Anchorage: Earth- or self-anchored
 - Side span length and support: Suspended, on piers or none
 - Girder continuity: Simply supported or continuous
- In all these solutions, cable planes are commonly vertical (construction process!) and common sag/span ratios range from $1/8 \dots 1/11$, with the following advantages of large/small sag:
 - large sag
 - lower cable forces = savings in cables and anchorages
 - small sag
 - stiffer cables = reduced deck girder bending moments, better aerodynamic behaviour
 - shorter towers and more elegant appearance
- The most economical sag/span ratio would be larger (about $1/6$, see Gimsing 2012), but deflections under traffic loads are excessive at such large sags (see *static analysis of cables*).

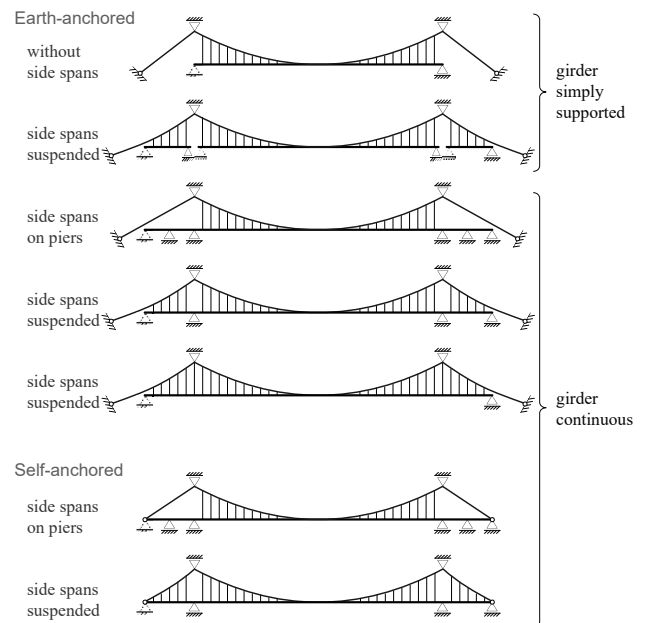

Suspension Bridges

Cable system
Preliminary cable dimensions

Suspension Bridges – Cable system: Preliminary cable dimensions

- In preliminary design, the main cable dimensions may be estimated based on a parabolic cable geometry and the dead load sag :

$$H = \frac{(g + g_m + q)l^2}{8f} + \frac{Ql}{4f} = \frac{(g + g_m + q)l^2 + 2Ql}{8f}$$

$$T \approx H \frac{\sqrt{l^2 + 16f^2}}{l} = \left[(g + g_m + q)l + 2Q \right] \frac{\sqrt{l^2 + 16f^2}}{8f}$$

- In the above equation, the main cable dead load g_m must first be estimated, requiring iteration. Knowing the cable strength f_{sd} and its specific weight γ_m (total cable weight per length / steel cross-sectional area), the equation can be solved for the required steel area A_m :

$$T = A_m f_{sd}, \quad g_m = A_m \gamma_m \rightarrow A_m \geq \frac{\left[(g + q)l + 2Q \right] \sqrt{l^2 + 16f^2}}{8f_{sd}f - \gamma_m l \sqrt{l^2 + 16f^2}}$$

The required hanger cross-section can be estimated by attributing to each hanger the uniformly distributed load (including traffic loads) corresponding to its part of the deck surface, assuming that concentrated loads are distributed over a length of $30d$:

$$T_h = \left(g + q + \frac{Q}{30d} \right) s_h \rightarrow A_h \geq \frac{T_h}{f_{sd}}$$

Estimation of suspension cable force (parabolic sag)

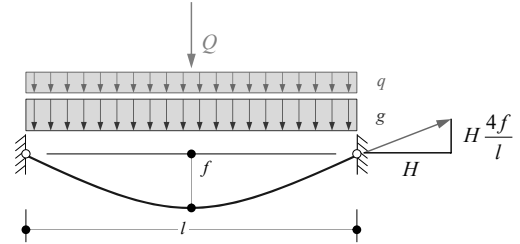

Estimation of hanger forces [Gimsing 2012]

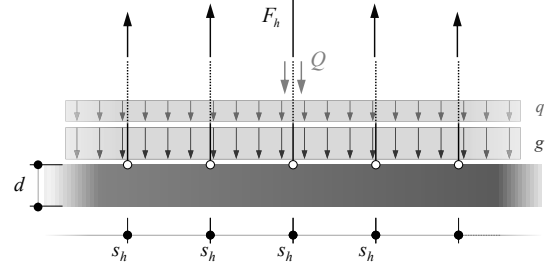

Suspension Bridges

Cable system

Earth anchored vs. self-anchored

Suspension Bridges – Cable system: Earth-anchored vs. self-anchored

- Conventional suspension bridges are earth-anchored
 - suspension cables are fixed to anchor blocks at their ends
 - stiffening girder carries no substantial axial force
- However, suspension bridges can also be self-anchored, just like cable-stayed bridges where this is the common solution:
 - suspension cables transfer the horizontal component of the cable force to the stiffening girder at their ends
 - stiffening girder carries compressive force of equal magnitude as the horizontal component of the cable force
- Self-anchored suspension bridges have the following advantages and drawbacks:
 - no need for anchor blocks (commonly heavy and expensive)
 - larger cross-section of stiffening girder required
 - complicated erection (suspension cables can carry loads only after stiffening girder is continuous, similar as in tied arches)
- The latter is a severe limitation, and hence, though the system was popular e.g. in Germany during the first decades of the 20th century, only few major self-anchored suspension bridges have been built, all of them with moderate spans.

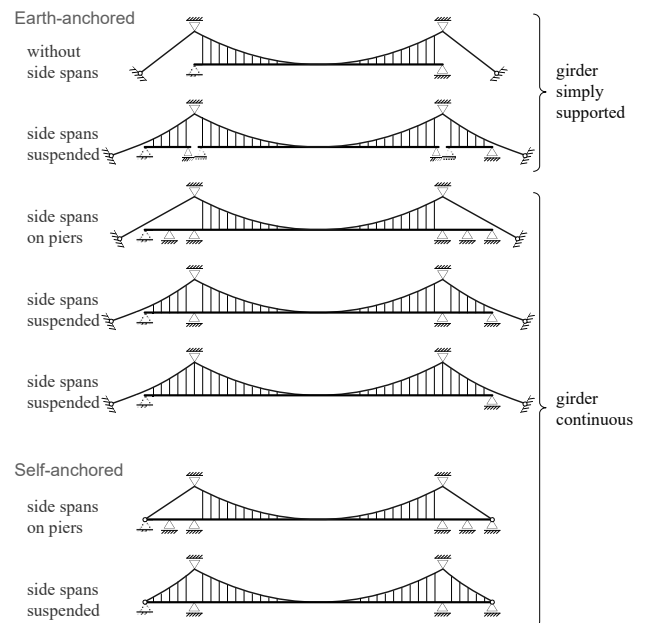

Self-anchored suspension bridges are analogous to tied arches. Not surprisingly thus, they were first proposed by Austrian engineer Josef Langer, who had also conceived the tied arch bridge (known as “Langerscher Balken” in German). He proposed to anchor the cables to the girder at their ends, as well as at midspan. In the U.S., Charles Bender patented a self-anchored suspension bridge system in 1867.

Suspension Bridges – Cable system: Earth-anchored vs. self-anchored

- The Konohana Bridge in Osaka, with a main span of 300 m (1990) is an example of an efficient (in the final state) and aesthetically appealing self-anchored suspension bridge.
- The construction process clearly showed the complexity of erecting major self-anchored suspension bridges – essentially, two bridges need to be built.



- The only recent example of a major self-anchored suspension bridge is the eastern section of the San Francisco-Oakland Bay bridge, which replaced the existing truss bridge in 2017, with a main span of 385 m.
- This bridge, whose design was won a design contest explicitly seeking a signature bridge, is “an extreme in complications during design and construction” according to Gimsing (2012). The final cost of \$6.5 billion – 25 times more than the initial estimate (note that the latter was a simple cantilever bridge, see comment in notes) – substantiates the criticism.



12.05.2023

ETH Zürich | Chair of Concrete Structures and Bridge Design | Bridge Design Lectures

15

Konohana Bridge, Osaka, Japan, H. Tanaka / Hitachi Hosen Corp., 1990. Self-anchored suspension bridge with one main cable, main span 300 m. Photo: Wikimedia commons, ignis.

Erection scheme and details: M. Kamei, T. Maruyama, G. Tanaka: Konohana Bridge, Japan. Structural Engineering International, IABSE, Vol. 2, No. 1, 1992.

Eastern section of the San Francisco-Oakland Bay bridge, USA. Self-anchored suspension bridge, main span 385 m. Photo Wikimedia Commons, Mariordo (Mario Roberto Durán Ortiz).

Wikipedia on Bay bridge: *Rather than retrofit the existing bridge, CalTrans (California Department of Transportation) decided to replace the entire eastern span. The design proposed was an elevated viaduct consisting of reinforced concrete columns and precast concrete segment spans as seen in the illustration at right. [...] The aesthetics of the proposal were not well received by either the public or their politicians, being characterized as a "freeway on stilts". After this, a design contest was held for a signature span (a span with distinctive and dramatic appearance, unique to the site) [...]. A number of innovative proposals were examined until all but four proposals that were submitted by members of EDAP were selected as semi-finalists, and a winner was selected from this group. This posed a serious conflict of interest, as members of the EDAP who were selecting the bridge design reviewed proposals by their own firms and rejected all proposals that did not have a representative on the EDAP. The design chosen was more expensive than the alternatives, because the primary structure cannot be self-supporting until it is structurally complete. This requires the building of two bridges, the first a falsework to support the final span, which would be removed upon completion of the final span. It has also been criticized as both a less structurally robust design and with less predictable construction costs than other modern spans.*

Further comment on cost of Bay bridge: The initial cost estimate was for the cantilever bridge that was not well received by the public. The excessive cost compared to this estimate is thus primarily due to the political process and the choice of a structurally inefficient (considering the construction process) concept, rather than cost overruns in the latter – though these were also substantial.

Suspension Bridges

Cable system

Vertical stiffness of cable system

Suspension Bridges – Cable system: Vertical stiffness of cable system

- The length of the side spans l_s has a pronounced effect on the stiffness under vertical traffic loads in the main span l_m , see section *static analysis of cables*, since the end span cables control the displacements of the tower top
 → the stiffness decreases with the length of the side span and the sag in these spans (girder weight).

- no side spans
 ... highest stiffness
 ... suitable if approaches on land are high enough

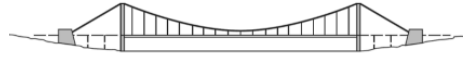

- short side spans: $l_s / l_m < 0.3$
 ... high stiffness
 ... common solution



- long side spans: $l_s / l_m = 0.4 \dots 0.5$
 ... low stiffness
 ... aesthetically pleasing

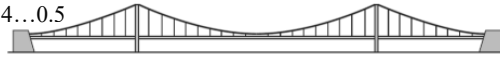

- extreme side spans: $l_s / l_m > 0.5$
 ... very low stiffness
 ... stiffening girder partly supported on "columns"

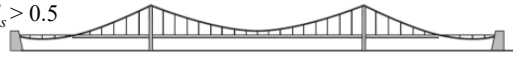

Second Bosphorus bridge: No side spans



Brooklyn bridge: Extreme side spans, $l_s / l_m = 0.59$



Second Bosphorus bridge, Istanbul, Turkey, BOTEK Technical Consultants, and Freeman Fox Partners (1986). Span 1090 m, no side spans.

Photo: Public Domain Pictures

Brooklyn Bridge over East River, New York, John A. Roebling (1866). Main span 486 m, side spans 284 m ($l_s / l_m = 0.59$).

Photo: michaelminn.net

Illustrations: Niels J. Gimsing, Christos T. Georgakis. Cable Supported Bridges – Concept and Design, Wiley, 1983 (3rd edition, 2012)

Suspension Bridges – Cable system: Vertical stiffness of cable system

- Even for short side spans, the stiffness under non-symmetrical traffic loads (half main span loaded) is often critical: Under such loads, the cables shift to the side with higher load (see section *static analysis of cables*, slide on effect of guy cables).
- This affects the vertical stiffness (both cables shifting to the same side), but also the torsional stiffness (cables on either side of stiffening girder shifting in opposite directions).
- A connection of suspension cables and stiffening girder via a **central clamp** is often provided to ensure a stiffer behaviour using the same effect as that of a guy cable.
- If the stiffening girder is longitudinally fixed, both the bending and torsional stiffnesses are increased by the clamp. While this is favourable for the vertical stiffness, it induces thermal restraint in the cable system (differential temperature of deck and cables), which may require special measures (such as devices permitting slow longitudinal movements, rather than fixed supports).
- If the stiffening girder is longitudinally movable, the clamp only increases the torsional stiffness. This may be favourable for the behaviour under wind loads (higher ratio of torsional / vertical frequency, see *wind-induced oscillations* section).

Deflection under traffic load in right half span (movable cable)

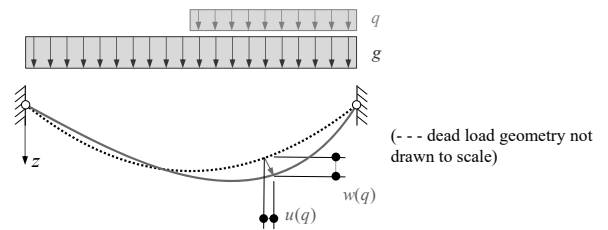

Different midspan connection types between cables and deck

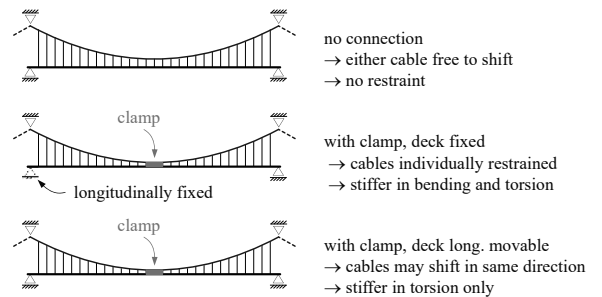

Suspension Bridges – Cable system: Vertical stiffness of cable system

- If the suspension cables and the stiffening girder intersect in elevation, simple solutions are feasible for the central clamps (top left, connection of cable and top chord of stiffening girder truss in the 25 de Abril Bridge, Lisbon).
- In other cases, a bracing is required, which may either be stiff (top right, Lillebaelt Bridge) or flexible (bottom, Bisan Seto Bridge).

Central clamps at midspan: Examples



Photos: Niels J. Gimsing, Christos T. Georgakis. Cable Supported Bridges – Concept and Design, Wiley, 1983 (3rd edition, 2012).

Suspension Bridges

Cable system

Horizontal stiffness of cable system

Suspension Bridges – Cable system: Horizontal stiffness of cable system

- Longitudinal forces (braking, acceleration) are resisted by the cable system if the stiffening girder is longitudinally movable at both ends. In the common case with vertical hangers, this involves a longitudinal displacement of the stiffening girder (longitudinal force resisted by inclination of hangers, short hangers carry most of longitudinal load)
 - feasible if longitudinal forces are moderate (road bridges)
- If longitudinal forces are high (train bridges), one of the following options may be chosen:
 - provide a central clamp (no longitudinal fixity of the stiffening girder required)
 - provide longitudinal fixity of the stiffening girder at one of the towers
 - provide hydraulic devices – actuators with a small bypass valve, permitting slow longitudinal displacements without restraint but blocking fast movements – at towers or anchor blocks (if deck is continuous)
- Hydraulic devices are common in long suspension bridges to limit thermal restraint in the cable system (differential temperature of deck and cables), see previous slides.

Longitudinal force transfer by short inclined hangers

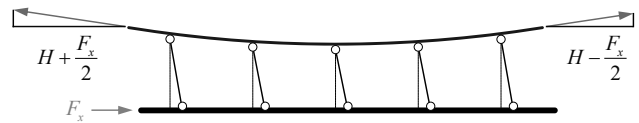

Example of hydraulic buffers at anchor blocks and central clamp (Storebaelt bridge [Gimsing 2012])

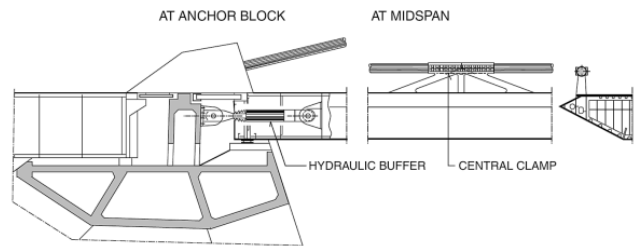

Bottom figure: Niels J. Gimsing, Christos T. Georgakis. Cable Supported Bridges – Concept and Design, Wiley, 1983 (3rd edition, 2012).

Suspension Bridges – Cable system: Horizontal stiffness of cable system

- A different solution to increase the stiffness are inclined hangers, such as in the Severn and Humber bridges, as well as the first Bosphorus bridge – all designed by Freeman, Fox & Partners. They proposed the inclined hangers mainly to enhance the aerodynamic stability of slender decks.
- As long as the hangers – which are loaded in tension by the deck self weight – do not decompress, a truss-like behaviour is achieved, similar to that in a Nielsen arch (see arch bridges chapter). In the 1960s, even network-suspension bridges had been proposed. If one main cable is used, and the hangers are connected to the outside of the deck, a triangular “truss-box girder” with very high torsional stiffness is achieved.
- Due to the variable sag, inclined hangers are aesthetically challenging. More importantly, detailing is more complicated and the stress range in the hangers increases, which may cause fatigue problems.
- Due to the latter, and because aerodynamic stability can be achieved by other means, inclined hangers have essentially been abandoned in suspension bridges after the First Bosphorus bridge, even in streamlined decks.



Suspension bridges with Inclined hangers and hanger network

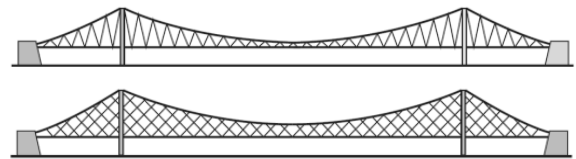

First Bosphorus Bridge, Istanbul, Turkey, Freeman Fox & Partners, 1973. Main span 1074 m.

Photo: Wikimedia Commons, Jorge1767 / Wallpapers Cities (bottom).

Figures: Niels J. Gimsing, Christos T. Georgakis. Cable Supported Bridges – Concept and Design, Wiley, 1983 (3rd edition, 2012).

Suspension Bridges – Cable system: Horizontal stiffness of cable system

- In earth-anchored suspension bridges, the cables also carry a substantial part of the transverse horizontal loads (wind, seismic loads), even if the cable planes are vertical.
- The behaviour, illustrated in the figure, is often referred to as “pendulum effect”: A horizontal displacement v of a cable by a vertical load F_z requires a transverse deviation force

$$F_y = F_z \frac{v}{h}$$

- Moisseiff’s extension of the deflection theory to lateral loads (see *historical perspective* section) is based on this effect, generalised to distributed loads.
- Since the horizontal forces are essentially proportional to the lateral deflection, the contribution of the cable system to the horizontal load transfer can be modelled (in analyses not accounting for large deformations) by horizontal springs with a stiffness

$$k_y = \frac{g}{h} \quad \left(\rightarrow q_y = k_y v = g \frac{v}{h} \right)$$

- If the towers are flexible in the transverse direction, the lateral stiffness of the cable system must be reduced accordingly.

Contribution of cable system to transfer of transverse loads

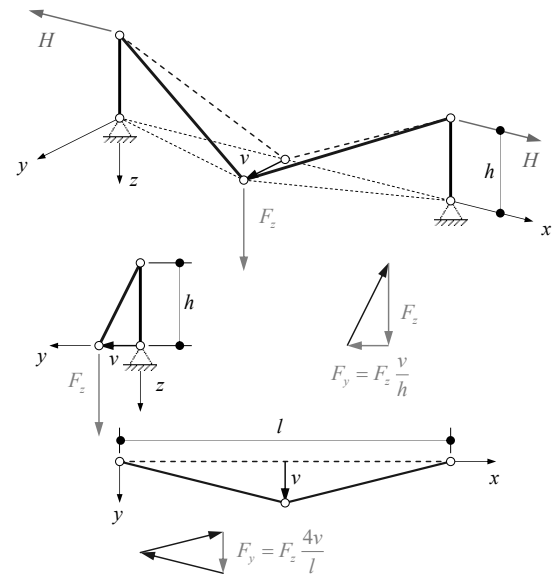

Suspension Bridges – Cable system: Horizontal stiffness of cable system

- In a long-span suspension bridge, lateral displacements of several meters are required to resist the full wind load by the pendulum effect of the cable system alone.
- In reality, the stiffening girder also carries a part of the lateral loads by bending (horizontal shear, bending moments around vertical axis).
- The system behaves essentially like a beam on elastic foundation (bottom figure, illustrated for cable-stayed bridge), i.e., the contribution of the cable system is dominant at large spans. In fact, as shown in the figure on the right, bending moments in the deck are not significantly affected by the span (almost equal for 600 or 1'200 m span).

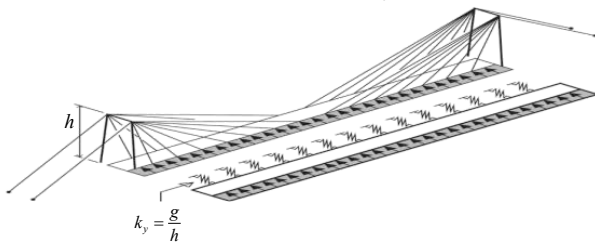

Moments due to lateral wind load on a suspension bridge with a 17 m wide, streamlined deck [Gimsing 2012]

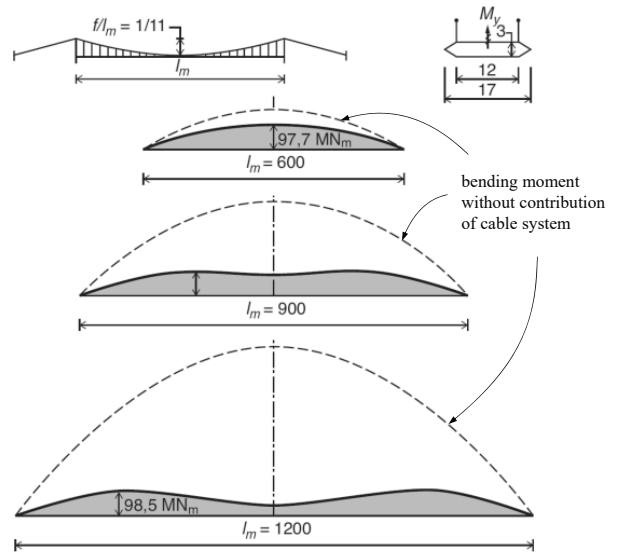

Figures: Niels J. Gimsing, Christos T. Georgakis. Cable Supported Bridges – Concept and Design, Wiley, 1983 (3rd edition, 2012).

Suspension Bridges – Cable system: Horizontal stiffness of cable system

- In self-anchored cable-supported bridges, this effect does not exist: The deviation forces of the cables (tension) are equilibrated by equal deviation forces of opposite sign in the stiffening girder (compression), see figure.
- Hence, in self-anchored suspension bridges (and cable-stayed bridges), the cables arranged in vertical planes do not contribute to the transverse load transfer.
- In such systems, spatial cable configurations, ensuring transverse load transfer by truss action, may be used (examples see below, cables must not decompress).

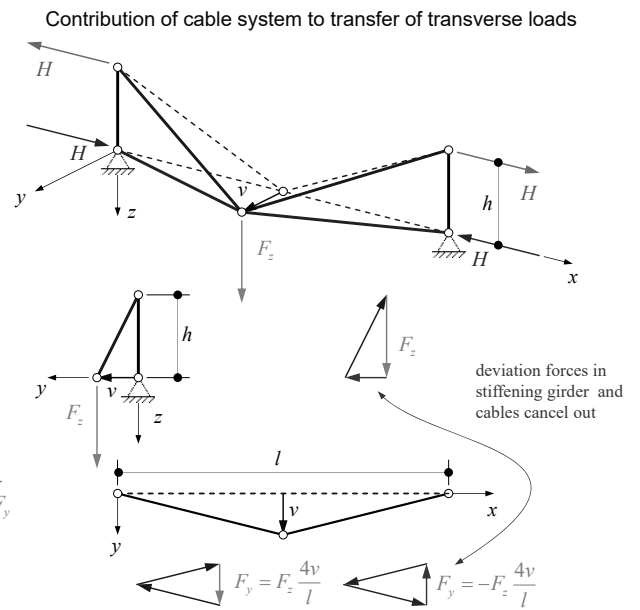
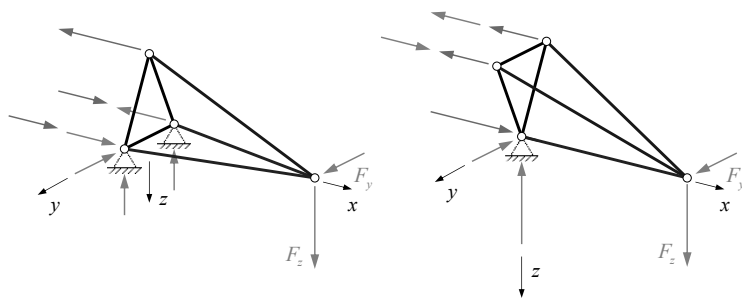

Suspension Bridges

Stiffening girder

Suspension Bridges – Stiffening girder

- In a conventional suspension bridge (earth-anchored, vertical hangers), the stiffening girder is not carrying substantial axial loads – a significant difference to cable stayed bridges.
- Generally, the functions of the stiffening girder are:
 - distribute concentrated loads
 - carry the load locally between cable anchor points
 - assist the cable system in carrying the load globally
- In suspension bridges, the contribution of the stiffening girder to the global load carrying behaviour is limited, since the cable system is stable by itself
 - stiffening girder mainly used to limit deformations
 - support conditions decisive
- Other than in cable-stayed bridges, simply supported stiffening girders are common in suspension bridges.
- Vertical support is commonly provided by end links, transferring no horizontal loads (left photo). Horizontal reactions are resisted by separate wind bearings (right photo).

Vertical support of suspension bridges

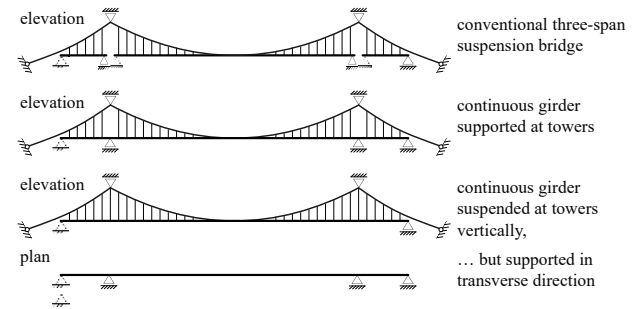

Vertical support at tower ("end links" [Gimsing 2012])



Lateral support at tower ("wind bearings" [Gimsing 2012])



Photos: Niels J. Gimsing, Christos T. Georgakis. Cable Supported Bridges – Concept and Design, Wiley, 1983 (3rd edition, 2012).

Suspension Bridges – Stiffening girder

- Continuous girders provide a higher stiffness, but attract high bending moments particularly at the tower supports.
- This can be avoided by avoiding vertical support at the towers, as e.g. in the Storebaelt bridge (photo).
- In the transverse direction, support is still provided to avoid excessive lateral deflections. This can be achieved using vertical sliding bearings (below, left figure).
- If the cable system does not provide sufficient torsional stiffness (e.g. one single cable plane), torsional support is required at the towers. Without vertical support, this is challenging (below, right figure).

Lateral support at tower using sliding bearings [Gimsing 2012]

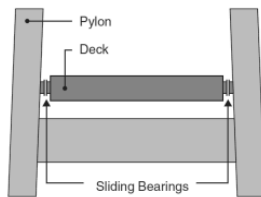

Lateral and torsional support at tower using sliding bearings [Gimsing 2012]

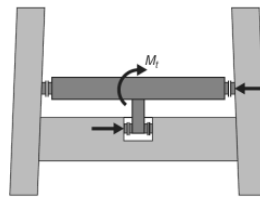

Illustrations: Niels J. Gimsing, Christos T. Georgakis. Cable Supported Bridges – Concept and Design, Wiley, 1983 (3rd edition, 2012).

Photo: Wikimedia commons.

Suspension Bridges – Stiffening girder

- Except for short spans, suspension bridges are generally provided with orthotropic steel decks. The higher cost compared to concrete decks is compensated by savings in the cable system and erection.
- The general layout of the cross-section of the stiffening girder is governed by the use of the bridge:
 - type of traffic and required number of traffic lanes
 - single or double deck
 - stiffness requirements (train bridges)
- Structurally, the following aspects – both related to aeroelastic stability – are decisive:
 - shape: streamlined box or bluff truss girder
 - torsional stiffness: open or closed cross-section
- Even if two cable planes (sufficient for torsional stability) are common in suspension bridges, closed cross-sections are used today to ensure a high torsional stiffness except for short spans (where cable-stayed bridges are more economical).
- These can be closed boxes or trussed box girders, see examples on the right (and many other slides).

Severn bridge (1966, span 978 m)

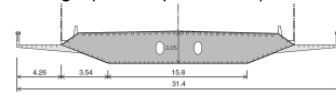

Lillebælt bridge (1970, span 600 m)

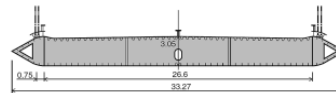

Bisan-Seto suspension bridges (1988, spans 990/1100 m)

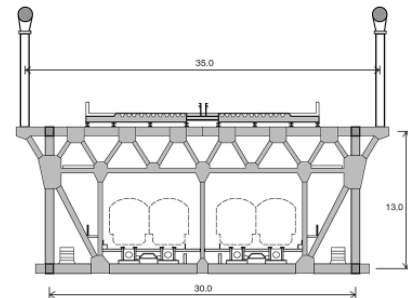

Severn Bridge, Severn River, UK, Freeman, Fox & Partners (now Arcadis), 1966. Main span 978 m.

Lillebælt Bridge, 1970. Main span 600 m.

Bisan-Seto suspension Bridges (1988). Main spans 990 and 1100 m.

Illustrations: Niels J. Gimsing, Christos T. Georgakis. Cable Supported Bridges – Concept and Design, Wiley, 1983 (3rd edition, 2012).

Suspension Bridges

Towers

Suspension Bridges – Towers

- In this lecture, the term tower is used for suspension bridges, whereas pylon is used for cable-stayed bridges. In practice, either term may be used for both bridge types.
- Towers of earth-anchored suspension bridges are typically provided with a high lateral stiffness. Other than in cable-stayed bridges, where pylons are often slender, second order effects (geometrical nonlinearities) are thus of minor importance.
- Towers of suspension bridges need to resist
 - loads originating from the deviation of the main cables at the top of the tower (primarily vertical load, governing design)
 - support reactions of the stiffening girder
 - wind loads acting on the tower
 - tower self-weight
- Steel and concrete towers have been used for the entire span range. While concrete towers are usually more economical, steel towers may be preferred due to other criteria (erection procedure, designers preferences, ...)

Portal-type pylon supporting an earth anchored suspension bridge [Gimsing 2012]

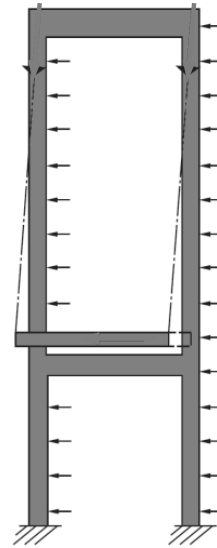

Illustration: Niels J. Gimsing, Christos T. Georgakis. Cable Supported Bridges – Concept and Design, Wiley, 1983 (3rd edition, 2012).

Suspension Bridges – Towers

- In this lecture, the term tower is used for suspension bridges, whereas pylon is used for cable-stayed bridges. In practice, either term may be used for both bridge types.
- Towers of earth-anchored suspension bridges are typically provided with a high lateral stiffness. Other than in cable-stayed bridges, where pylons are often slender, second order effects (geometrical nonlinearities) are thus of minor importance.
- Towers of suspension bridges need to resist
 - loads originating from the deviation of the main cables at the top of the tower (primarily vertical load, governing design)
 - support reactions of the stiffening girder
 - wind loads acting on the tower
 - tower self-weight
- Steel and concrete towers have been used for the entire span range. While concrete towers are usually more economical, steel towers may be preferred due to other criteria (erection procedure, designers preferences, ...)

Portal-type tower with vertical legs connected by cross-beams [Gimsing 2012]

Diagonally braced tower with vertical legs [Gimsing 2012]

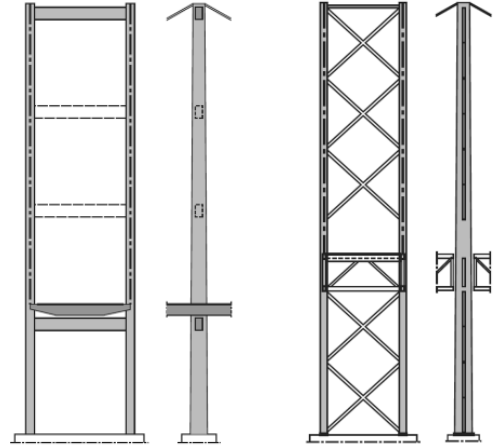

Illustration: Niels J. Gimsing, Christos T. Georgakis. Cable Supported Bridges – Concept and Design, Wiley, 1983 (3rd edition, 2012).

Suspension Bridges – Towers

- In this lecture, the term tower is used for suspension bridges, whereas pylon is used for cable-stayed bridges. In practice, either term may be used for both bridge types.
- Towers of earth-anchored suspension bridges are typically provided with a high lateral stiffness. Other than in cable-stayed bridges, where pylons are often slender, second order effects (geometrical nonlinearities) are thus of minor importance.
- Towers of suspension bridges need to resist
 - loads originating from the deviation of the main cables at the top of the tower (primarily vertical load, governing design)
 - support reactions of the stiffening girder
 - wind loads acting on the tower
 - tower self-weight
- Steel and concrete towers have been used for the entire span range. While concrete towers are usually more economical, steel towers may be preferred due to other criteria (erection procedure, designers preferences, ...)

Portal-type tower:
Humber Bridge



Diagonally braced tower:
Akashi-Kaikyo bridge



Suspension Bridges – Towers

- If the stiffening girder is simply supported, it will be interrupted at the towers in any case:
 - centre cable planes in vertical leg axes (see previous slide)
 - ensure passage of full traffic lanes (upper figure)
 - pedestrian lanes may pass outside tower legs
- If the stiffening girder is continuous at the towers, it is preferable to provide passage to the full width of the cross-section. The following tower geometries enable this:
 - slightly inclined legs, cross-beam at top to deviate cable forces in leg direction (bottom left figure)
 - vertical legs, saddles positioned eccentrically (with respect to leg axes) on stiff cross-beam ensuring load transfer
- With continuous stiffening girders, the tower cross-beam under the girder can be omitted if the girder is continuously supported by hangers (e.g. Storebaelt bridge, see previous slides).

Simply supported stiffening girder detail at towers
[Gimsing 2012]

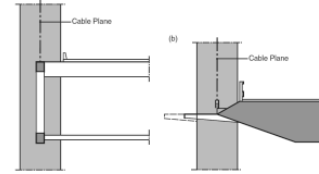

Tower geometries for continuous stiffening girder
[Gimsing 2012]

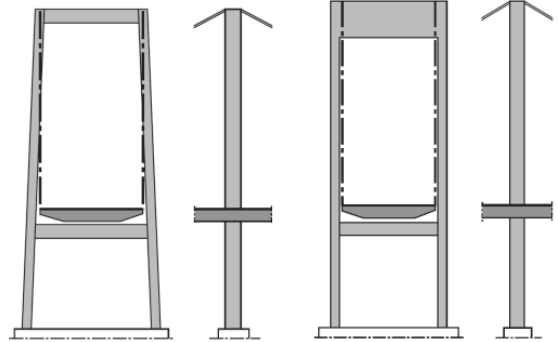

Illustrations: Niels J. Gimsing, Christos T. Georgakis. Cable Supported Bridges – Concept and Design, Wiley, 1983 (3rd edition, 2012).

Suspension Bridges – Towers

- In the longitudinal direction, the towers of earth-anchored suspension bridges are stabilised by the side-span cables. Hence, the buckling length of the towers corresponds to roughly 70% of their height.
- Except in multi-span arrangements, the towers of suspension bridges are thus relatively slender in the longitudinal direction.
- A high longitudinal slenderness is favourable, as it reduces bending moments in the tower due to side span cable elongations. On the other hand, stability in the construction stages must be guaranteed.
- Commonly, major suspension bridge towers are slightly tapered longitudinally, having a width of $1/20 \dots 1/25$ of the tower height.
- Early suspension bridges had stone masonry towers (the towers of the George Washington Bridge were originally going to be clad with marble, since stone was considered appropriate). Later on, steel towers became standard, often using highly complex, structurally inefficient cross-sections (figure).
- Modern suspension bridge towers are built with efficient single-cell hollow cross-sections, either in steel or concrete (figure).

Tower of Verrazzano Narrows Bridge (1964) [Gimsing 2012]

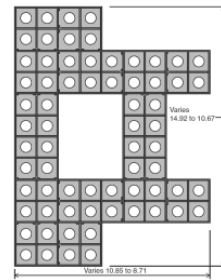

Tower of Storebælt bridge (1998) [Gimsing 2012]

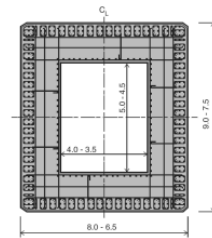

Illustrations: Niels J. Gimsing, Christos T. Georgakis. Cable Supported Bridges – Concept and Design, Wiley, 1983 (3rd edition, 2012).

Photos: Wikiwand.com

Suspension Bridges – Towers

- The main cables of suspension bridges are deviated at the tower top by means of saddles. This is also possible in cable-stayed bridges, where the cables are, however, more often anchored at the pylon top (see *cable-stayed bridges* section).
- The saddles ensure a continuous curvature of the suspension cables, and are commonly fixed horizontally to the tower (top left).
- During erection, longitudinal relative displacements between tower and saddle (hence, cable) are sometimes enabled (top right) in order to be able to reduce bending moments in the tower legs.
- The radius of the saddle is determined by the allowable lateral pressure on each strand of the suspension cable, which is limited to avoid reductions of the axial cable strength (particularly fatigue).
- The allowable pressure ranges from [Gimsing 2012]
 - 0.7...1.8 kN/mm for parallel wire strands and
 - 1.0...2.0 kN/mm for locked-coil strands
 - (the higher value applies if soft metal sheaths ≥ 2 mm are inserted between strand and saddle, or a thick galvanising ≥ 2 mm is provided)

Saddle types [Gimsing 2012]
(right: movable during construction, fixed in final stage)

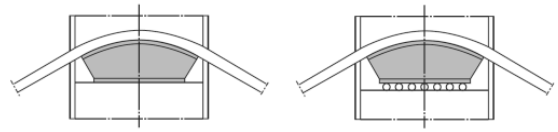

Tower saddle of Third Bosphorus Bridge



Illustrations: Niels J. Gimsing, Christos T. Georgakis. *Cable Supported Bridges – Concept and Design*, Wiley, 1983 (3rd edition, 2012).

Photo: Jean-François Klein, Thierry Delémont: 3^{ème} Pont sur le Bosphore – *Conception et construction*, SZS steelacademy, Journée d'étude sur les ponts 2016.

Suspension Bridges – Towers

- Suspension bridge towers are commonly longitudinally flexible, and the horizontal component of suspension cable forces on either side of the saddle are thus (approximately) equal, $H_l = H_r$.
- However, due to different cable inclinations in main span and side span, the cable force varies, $T_l < T_r$ for $\varphi_l > \varphi_r$. The differential cable force $T_r - T_l$ is transferred by friction, and the maximum force T_r for a given value of T_l is thus:

$$T_{r,\max} = T_l \cdot e^{\mu(\varphi_l + \varphi_r)} \approx T_l \cdot [1 + \mu(\varphi_l + \varphi_r)]$$

(for derivation see lecture Stahlbeton II, Reibungsverluste).

- The friction coefficient μ is generally quite low ($\mu \approx 0.1$), such that only moderate cable force differences can be absorbed. If the cable inclinations differ strongly, such as in bridges with short side spans, a cover with pre-tensioned bolts may be pressed against the cable. If m bolts with a preload P_b are used, one gets:

$$T_{r,\max} = T_l \cdot e^{\mu(\varphi_l + \varphi_r)} + 2\mu m P_b \approx T_l \cdot [1 + \mu(\varphi_l + \varphi_r)] + 2\mu m P_b$$

- In the latter case, it may also be useful to increase the number of strands in the side span, see lower figures. Note that the horizontal component of the cable force is still approximately constant.

Frictional forces on cable passing over simple saddle [Gimsing 2012]



Frictional forces on cable passing over saddle with cover [Gimsing 2012]

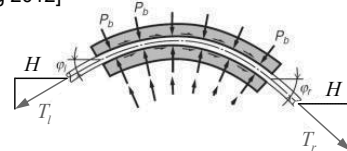

Saddle with additional strands for side span cable, anchored on the saddle above continuous strands [Gimsing 2012]

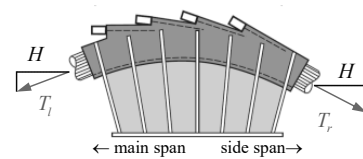

Illustrations: Niels J. Gimsing, Christos T. Georgakis. Cable Supported Bridges – Concept and Design, Wiley, 1983 (3rd edition, 2012).

Suspension Bridges

Anchor blocks

Suspension Bridges – Anchor blocks

- In earth-anchored suspension bridges, the full cable forces are transferred to the soil through anchor blocks, commonly made from concrete.
- Cable forces are transferred by anchoring the individual strands of the suspension cable. To enable this anchorage, each cable is split into its strands by means of a splay saddle (Spreizsattel).
- The strands are deviated downwards from the cable tangent, and arranged in the order they are added during erection. In many cases, they are also flared horizontally, requiring a double curvature of the splay saddle grooves.
- The splay saddles need to accommodate axial displacements of the cable due to thermal expansion and contraction (of the splayed strands). In recent bridges (Storebælt, Hardanger, 3rd Bosphorus bridge,...), splay saddles were designed as large pendulums for this reason.

Splay saddle: Elevation and example (Hardanger bridge)
[Gimsing 2012]

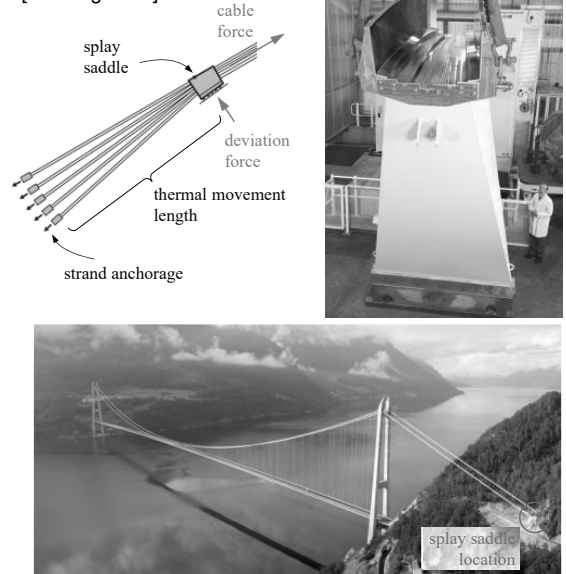

Splay saddle of Hardanger Bridge (Hardanger Fjord, 2013, span 1'310 m.

Photo © Goodwin International Ltd.

Hardanger bridge, Hardanger Fjord, Norway, Aas-Jakobsen, 2013. Span 1'310 m.

Photo Wikimedia commons, kronja.

Suspension Bridges – Anchor blocks

- Behind the splay saddle, the strands run through the splay chamber, and are anchored at the bottom of this chamber by means of strand shoes or sockets.
- The strand forces are transferred to the anchor block by steel rods, eye-bars or tendons embedded in the concrete.
- The wires of air-spun cables in older bridges were commonly anchored by looping them around eyebars (example: Tacoma Narrows Bridge, 1950).

Splay chamber of 3rd Bosphorus Bridge [Klein+Delémont, 2016]

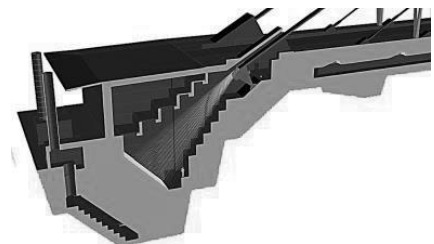
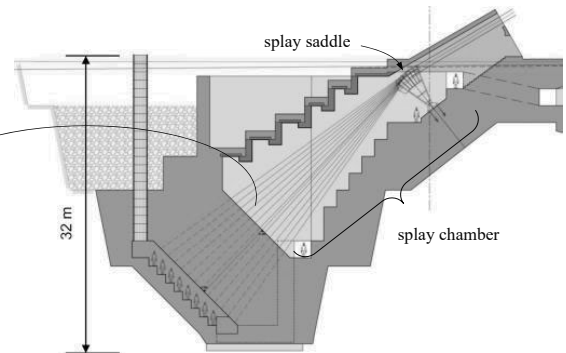

Illustration and Photos: Jean-François Klein, Thierry Delémont: 3^{ème} Pont sur le Bosphore – Conception et construction,» SZS steelacademy, Journée d'étude sur les ponts 2016.

(except historical photo of Tacoma Narrows cable anchorage, wsdot.org)

Suspension Bridges – Anchor blocks

- The anchor blocks are commonly designed as gravity structures, transferring the cable forces – together with the anchor block self weight – to the ground (upper figure)
- To keep dimensions small and/or limit underwater excavation, ballast may be used.
- If solid rock is present at the bridge ends, anchorages can be embedded in the rock (lower figure).
- Unless embedded in ground, anchor blocks are massive structures with a high visual impact and need to be designed carefully.



Gravity-type anchor block of Storebælt bridge [Gimsing 2012], with schematic forces

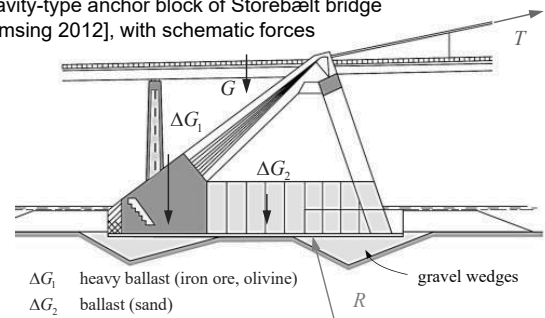

Rock anchorage, Firth of Forth Suspension bridge [Gimsing 2012]

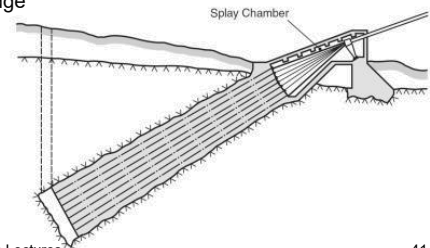

Illustrations: Niels J. Gimsing, Christos T. Georgakis. Cable Supported Bridges – Concept and Design, Wiley, 1983 (3rd edition, 2012).

Suspension Bridges

Stress-ribbons

Suspension Bridges

Stress-ribbons – General aspects

Suspension bridges – Stress-ribbons: General aspects

- In suspended bridges, the deck follows the cable profile in elevation, and the traffic loads act directly on the suspension cables. Essentially, in elevation, such bridges behave as cables.
- As outlined in the section *static analysis of cables* (selected illustrations repeated on right) cables are
 - stiff under funicular loads (loads for which the cable's initial geometry is funicular, commonly dead load)
 - very flexible structures under non-funicular loads
- The large deformations of suspended bridges are limiting their field of application to trail and pedestrian bridges with alternative routes (wheelchairs).
- The stiffness of suspended bridges under non-funicular load can be enhanced by
 - increasing cable tension (see section static analysis of cables) by
 - ... adding weight or
 - ... reducing sag
 - adding bending stiffness (deck, stiffening girder)

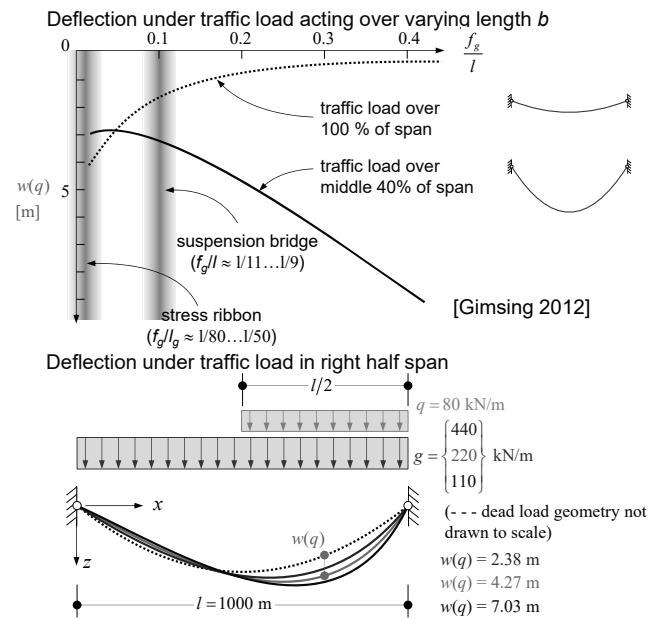

Illustrations: Niels J. Gimsing, Christos T. Georgakis. Cable Supported Bridges – Concept and Design, Wiley, 1983 (3rd edition, 2012).

Suspension bridges – Stress-ribbons: General aspects

- Stress-ribbons are suspended bridges with a slender, yet reasonably stiff deck (usually prestressed concrete) which:
 - increases the cable tension (weight of concrete) and
 - adds bending stiffness to the system.
- If, in addition to the above measures, a small sag is chosen, stress-ribbons are stiff enough to be used as footbridges, satisfying the respective serviceability criteria.



Reference: Peter Marti: Theory of Structures. Wiley, 2013.

Sacramento River Bridge, Redding CA, USA. Charles Redfield and Jiri Straski, 1990. Span 127.4 m, deck thickness 0.38 m,

Bridgeofweek.com/2014/10/shasta-county-california-bridges_21.html

Recommended reading: Jiri Strasky. stress-ribbon and cable-supported pedestrian bridges. Thomas Telford, 2004.

Suspension bridges – Stress-ribbons: General aspects

- The main advantage of stress-ribbons is their minimal environmental impact, both visually as well as materially:
 - slender, minimalist appearance
 - low material consumption
 - erection without falsework or shoring affecting the natural environment
- The main disadvantage of classical stress-ribbon structures is the requirement of very high horizontal forces at the abutments, which determines the economy of that solution in many cases.
- In most cases, these high horizontal forces are not primarily required to increase stiffness under traffic loads, but to guarantee serviceability, i.e. respect the maximum longitudinal slope.
- For example, assuming a maximum admissible slope of 6% (wheelchairs, bike routes), a sag/span ratio of $f/l < 1/67$ is required, i.e., more than six times less than in a typical suspension bridge. Even for narrow footbridges, this results in very high cable forces.

Geometry of a stress-ribbon under uniform load (parabolic geometry)

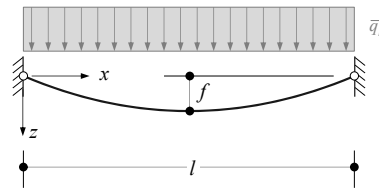

$$\left. \begin{array}{l} \text{Cable force: } H = \frac{\bar{q}_k l^2}{8f} \\ \text{Maximum slope: } z' = \frac{4f}{l} \end{array} \right\} \rightarrow f \leq z'_{adm} \cdot \frac{l}{4}, \quad H \geq \frac{\bar{q}_k l}{2z'_{adm}}$$

Example: (2.5 m wide bridge, dead load only considered to verify maximum slope z'_{adm}):
 $l = 100 \text{ m}$, $z'_{adm} = 6\%$, $\bar{q}_k \approx 20 \text{ kN/m}$
 $\rightarrow f \leq 1.50 \text{ m}$
 $\rightarrow H \geq 16.7 \text{ MN}$

Illustrations: Niels J. Gimsing, Christos T. Georgakis. Cable Supported Bridges – Concept and Design, Wiley, 1983 (3rd edition, 2012).

Suspension Bridges

Stress-ribbons – Analysis

Suspension bridges – Stress-ribbons: Analysis

- Since stress-ribbons usually have a constant cross-section and the sag is very small, their shape is almost exactly a second order parabola (deviation from catenary marginal).
- The behaviour of stress-ribbons can be analysed by accounting for the combined cable-type and bending response, see section *static analysis of cables*. As outlined by Marti (Theory of Structures, 2013, Chapter 18.9), the differential equation

$$EIw'''' - (H + \Delta H)w'' = q - g \frac{\Delta H}{H} \quad (H = H(g), \Delta H = \Delta H(q))$$

with the solution

$$w = c_1 + c_2x + c_3 \cosh(\lambda x) + c_4 \sinh(\lambda x) + w_{part} \quad \left(\lambda = \frac{H + \Delta H}{EI} \right)$$

covers the entire spectrum from a pure bending response only ($\lambda = 0$), to a pure cable-type response ($\lambda \rightarrow \infty$). Note that it has been assumed in the derivation of the differential equation that the dead load g is carried by cable tension alone.

- In practice, the same software programs as used for suspension bridges, capable of accounting for large deformations, are used for detailed design.

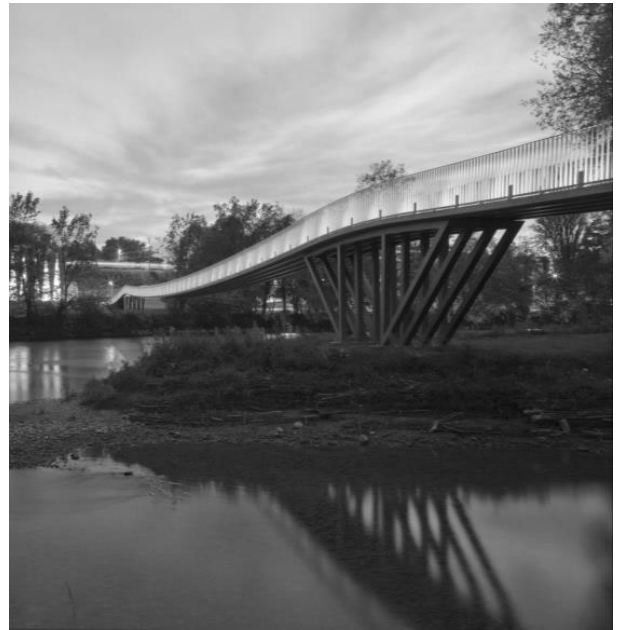

Reference: Peter Marti: Theory of Structures. Wiley, 2013.

Aaresteg Mülimatt, Brugg-Windisch, Switzerland, Conzett Bronzini Gartmann AG, 2010. Spans 30+78+35+30m. Steel-concrete composite deck. Photo: <https://www.ag.sia.ch/sia-aargau-preis/>
Photo www.cbp.ch

Recommended reading: Jiri Strasky. stress-ribbon and cable-supported pedestrian bridges. Thomas Telford, 2004.

Suspension bridges – Stress-ribbons: Analysis

- In preliminary design, stress-ribbons may be analysed neglecting the bending stiffness (as cables). The cable equation (see section *static analysis of cables*) can be applied directly.
- The analysis must account for the different erection and service stages, see figure.
- The basic stage – shape and stresses at the end of the erection, after hardening of the concrete joints (i.e., change from cable to stress-ribbon behaviour) – is decisive for the stresses in the structure during all future stages.
- However, the geometry is usually defined based on the dead load configuration after prestressing (step e). Since this geometry depends on the basic stage, iterative calculations are required.
- The calculations need to account for the change in sag due to traffic loads and thermal effects (reduced sag at cold temperature causes higher cable forces under same vertical load).
- For more details, see sources in notes.

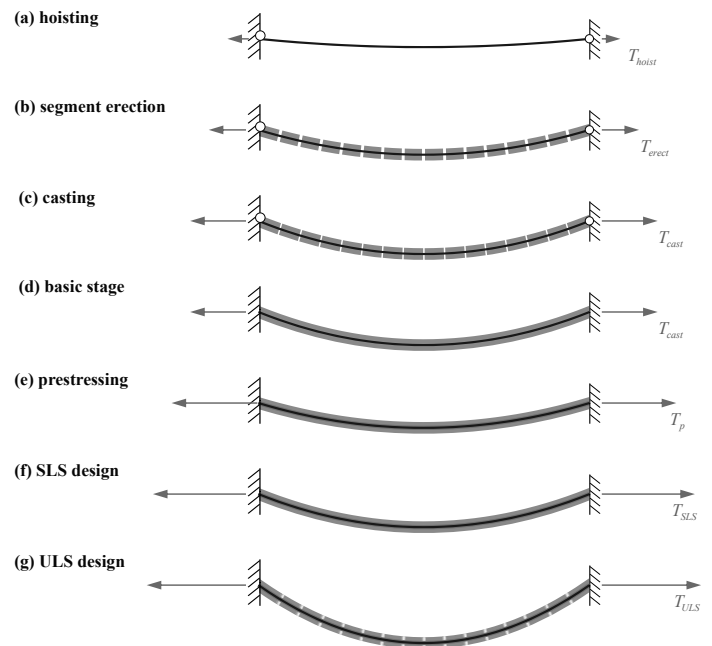

Sources:

W.F. Chen and L. Duan (Ed.). Bridge Engineering Handbook. Second Edition, Five Volume Set, CRC Press / Taylor and Francis, 2014

Jiri Strasky. stress-ribbon and cable-supported pedestrian bridges. Thomas Telford, 2004.

Suspension bridges – Stress-ribbons: Analysis

- In preliminary design, stress-ribbons may be analysed neglecting the bending stiffness (as cables). The cable equation (see *static analysis of cables*) can be applied.

$$\frac{l}{2} \left[\sqrt{1+\beta^2} + \frac{\ln(\beta + \sqrt{1+\beta^2})}{\beta} \right] = L \left(1 + \alpha_T \Delta T - \frac{\sigma_0}{E} \right) + \frac{\bar{q}l^2}{2EA \cdot \beta} \left(1 + \frac{\beta^2}{3} \right)$$

- The analysis must account for the different erection and service stages, see figure.
- The basic stage – shape and stresses at the end of the erection, after hardening of the concrete (i.e., change from cable to stress-ribbon behaviour) – is decisive for the stresses in the structure during all future stages.
- However, the geometry is usually defined based on the dead load configuration after prestressing (step e). Since this geometry depends on the basic stage, iterative calculations are required.
- The calculations need to account for the change in sag due to traffic loads and thermal effects (reduced sag at cold temperature causes higher cable forces).
- For more details, see sources in notes.

(a) hoisting
 → hoist bearing tendons
 → adjust tension (force, sag)
 → anchor bearing tendons

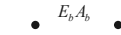

(b) segment erection
 → erect precast segments
 → connect segments in joints

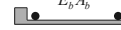

(c) casting
 → install prestressing tendons
 → cast in-situ concrete
 → bearing tendons carry all load

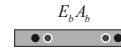

(d) basic stage
 → concrete hardened
 → ready for prestressing

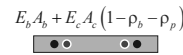

(e) prestressing
 → tension prestressing tendons (sag decreases)
 → anchor prestressing tendons

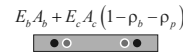

(f) SLS design
 → uncracked ribbon
 → characteristic loads (traffic, temperature (±), creep & shrinkage)

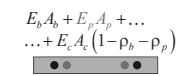

(g) ULS design
 → fully cracked ribbon
 → factored loads (traffic, temperature (-) full creep & shrinkage)

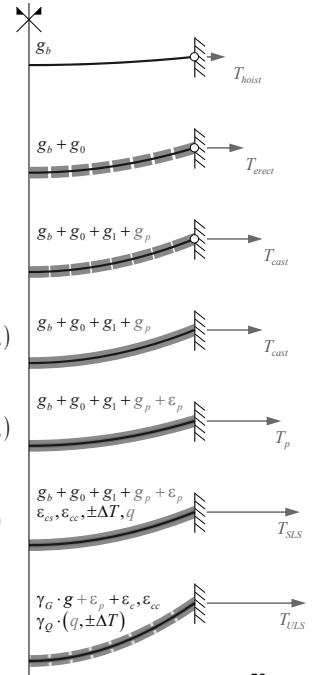
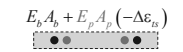

Sources:
$$\frac{l}{2} \left[\sqrt{1+\beta^2} + \frac{\ln(\beta + \sqrt{1+\beta^2})}{\beta} \right] = L \left(1 + \alpha_T \Delta T - \frac{\sigma_0}{E} \right) + \frac{\bar{q}l^2}{2EA \cdot \beta} \left(1 + \frac{\beta^2}{3} \right)$$

 W.F. Chen and L. Duan (Ed.). Bridge Engineering Handbook. Second Edition, Five Volume Set, CRC Press / Taylor and Francis, 2014

Jiri Strasky. stress-ribbon and cable-supported pedestrian bridges. Thomas Telford, 2004.
 where $\beta = \frac{4p}{l}$ and $\frac{l}{2} \left[\sqrt{1+\beta^2} + \frac{\ln(\beta + \sqrt{1+\beta^2})}{\beta} \right] \approx l \left(1 + \frac{\beta}{6} - \frac{\beta^2}{40} \right)$

Suspension bridges – Stress-ribbons: Analysis

Example (as used for combined cable and bending behaviour in Cable Supported Bridges Part 2, Slide 87 ff):

Elevation

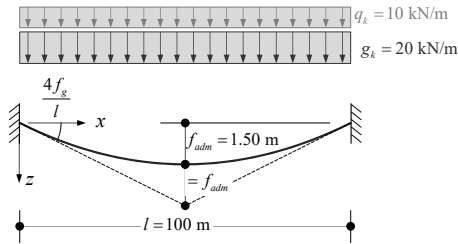

Cross-section

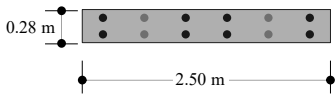

$A_c = 0.28 \cdot 2.5 = 0.70 \text{ m}^2$ $g_c = 17.5 \text{ kN/m}^2$ (concrete)
 $A_b = 88 \cdot 150 = 13'200 \text{ mm}^2$ $g_b = 1.04 \text{ kN/m}^2$ (8 · 11 Ø0.6" = bearing tendons)
 $A_p = 48 \cdot 150 = 7'200 \text{ mm}^2$ $g_p = 0.57 \text{ kN/m}^2$ (4 · 12 Ø0.6" = prestressing tendons)

20 x higher load
→ 16 x larger sag f
→ 1.2 x higher force

40% higher load
→ 36% larger sag f
→ 3% higher force

(note effect of ΔT)

(a) hoisting ($\Delta T=0$)

$EA = 2.64 \text{ GN}$
 $T = 11.3 \text{ MN}$
 $f = 0.115 \text{ m}$

(b) segment erection ($\Delta T=0$)

$EA = 2.64 \text{ GN}$
 $(T, f \text{ depend on weight of precast segments})$

(c) casting ($\Delta T=0$)

$EA = 2.64 \text{ GN}$
 $T = 13.6 \text{ MN}$
 $f = 1.838 \text{ m}$

(d) basic stage ($\Delta T=0$)

$EA = 23.0 \text{ GN}$
 $T = 13.6 \text{ MN}$
 $f = 1.838 \text{ m}$

(e) prestressing ($\Delta T=0$)

$EA = 23.0 \text{ GN}$
 $T = 16.7 \text{ MN}$
 $f = 1.50 \text{ m}$ (= admissible sag)

(f) SLS design ($\Delta T = \pm 20^\circ\text{C}$)

$EA = 25.1 \text{ GN}$
 $T = 19.8 \dots 23.1 \text{ MN}$
 $f = 1.89 \dots 1.63 \text{ m}$

(g) ULS design ($\Delta T = -20^\circ\text{C}$)

$EA = 4.08 \text{ GN}$ (fully cracked)
 $T = 23.7 \text{ MN}$
 $f = 2.211 \text{ m}$

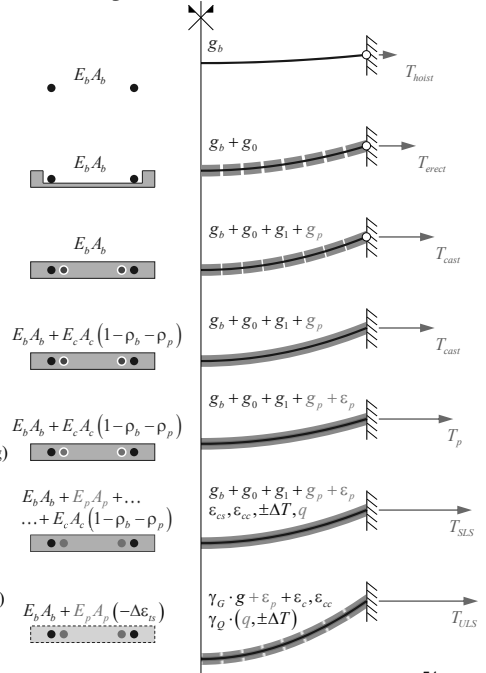

Sources:

W.F. Chen and L. Duan (Ed.). Bridge Engineering Handbook. Second Edition, Five Volume Set, CRC Press / Taylor and Francis, 2014

Jiri Strasky. stress-ribbon and cable-supported pedestrian bridges. Thomas Telford, 2004.

Suspension Bridges

Stress-ribbons – Selected design aspects

Suspension bridges – Stress-ribbons: Selected design aspects

- Stress-ribbon bridges can have one or more spans.
- In multi-span stress-ribbons, the horizontal force should be constant in all spans to avoid large horizontal loads on the intermediate piers. A constant horizontal force (under equal load) corresponds to sags proportional to the squared length of each span.

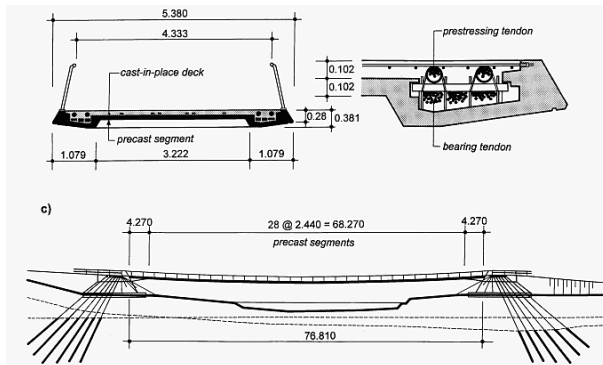

Bridge across the Blue River, Colorado, USA, Charles Redfield and Jiri Strasky, 2001. Span 76.8 m. Photo and figure shp.com.

Completed in 2001

Lake Hodges Bikeway Access, San Diego, California, USA, T.Y. Lin and Jiri Strasky, 2009. Spans 3x100.58 m, deck thickness sag 1.41.m. Photo shp.com.

Suspension bridges – Stress-ribbons: Selected design aspects

- A typical stress-ribbon cross-section cannot resist the bending moments near the supports (abutments, piers), where large curvatures occur, mainly due to prestressing and thermal effects (see *static analysis of cables*)
- The support bending moments can be reduced by
 - supporting the stress-ribbon on a saddle from which it can lift during post-tensioning and temperature drop, and to which the band can return for a temperature increase (left figures)
 - Strengthening the stress-ribbon with a short support haunch (right figures), which will, however in turn attract higher moments.

End support details for stress-ribbon bridges [Strasky 2004]

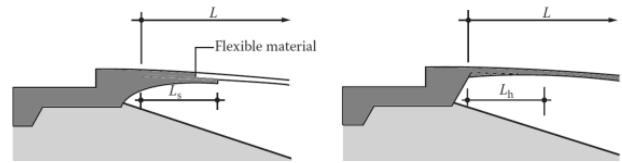

Pier support details for stress-ribbon bridges [Strasky 2004]

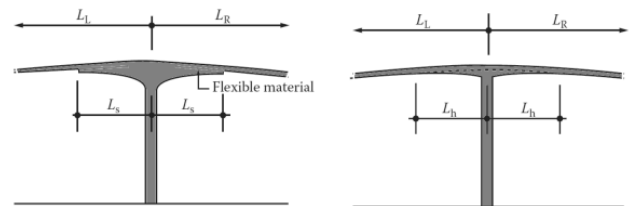

Sources:

W.F. Chen and L. Duan (Ed.). Bridge Engineering Handbook. Second Edition, Five Volume Set, CRC Press / Taylor and Francis, 2014

Jiri Strasky. stress-ribbon and cable-supported pedestrian bridges. Thomas Telford, 2004.

Suspension bridges – Stress-ribbons: Selected design aspects

- In order to minimise bending moments in intermediate piers, hinges (preferably concrete hinges for low maintenance) may be provided at the foot (figure).



Pier of Prague-Troja stress-ribbon bridge [Strasky 2004]

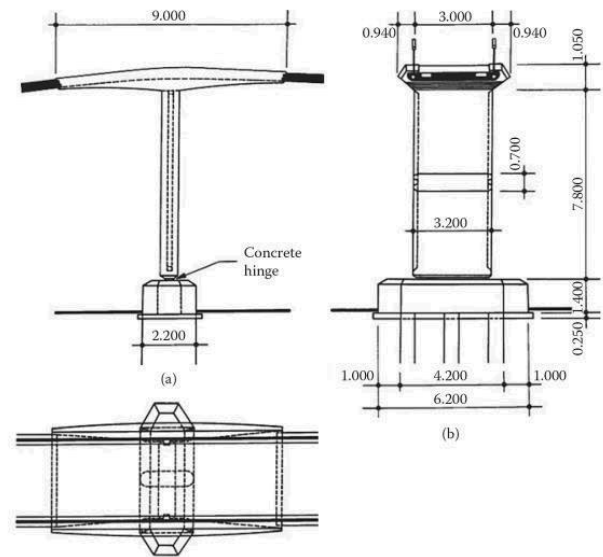

Prague-Troja Bridge, intermediate pier. Source: W.F. Chen and L. Duan (Ed.). Bridge Engineering Handbook. Second Edition, Five Volume Set, CRC Press / Taylor and Francis, 2014 (digital full-text access via ETH Library).

Prague-Troja stress-ribbon footbridge, Jiri Staasky, 1984. stress-ribbon, main span 96 m, sag 1.69 m, total length 261 m. Collapsed on 2.12.2017, presumably due to corrosion.

Suspension bridges – Stress-ribbons: Selected design aspects

- Stress-ribbons are commonly fixed at end anchor blocks that are integral parts of the abutments.
- Due to the low sag (see previous slides), the abutments need to transfer very high horizontal forces to the soil. Anchorage is commonly done by
 - Rock or ground anchors (combined with micropiles acting in compression at the front of the abutment except in very stiff soil at foundation level)
 - Micropiles forming a “triangulation” (lower figure)
- Safety against overturning and sliding must be guaranteed not only in the final stage, but also during construction. The anchors may therefore have to be stressed in two stages (e.g. 50% initially, full prestress after activation of stress-ribbon self weight).
- Due to the low sag, stress-ribbons are very sensitive to horizontal deformations (see *static analysis of cables*). The anchorages should thus be as stiff as possible. The above solutions are therefore preferred to large diameter piles loaded transversally, which are much more flexible. In any case, significant flexibility of the anchorages must be accounted for in the design.

End anchorage by rock anchors [Strasky 2004]

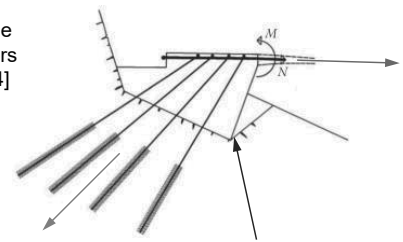

End anchorage by micropiles [Strasky 2004]

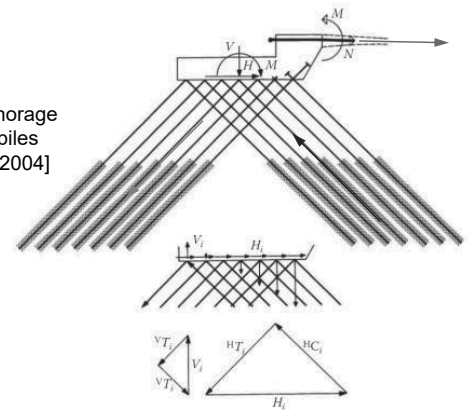

Sources:

W.F. Chen and L. Duan (Ed.). Bridge Engineering Handbook. Second Edition, Five Volume Set, CRC Press / Taylor and Francis, 2014

Jiri Strasky. stress-ribbon and cable-supported pedestrian bridges. Thomas Telford, 2004.

Suspension Bridges

Stress-ribbons – Erection

Suspension bridges – stress-ribbons: Erection

- Erection of stress-ribbon bridges requires no falsework nor shoring, since installation is done using bearing tendons (which are activated for ULS design, no temporary cables).
- A typical erection sequence is as follows:
 - Install bearing tendons using a winch
 - Tension bearing tendons to prescribed stress.
 - Erect prefabricated segments near the abutment (crane truck)
 - place segment under bearing tendons
 - hang segment to bearing tendons (such that it can slide)
 - Move segment to final position along the bearing tendons using a winch and attach to previously installed segments
 - Fix saddle formwork at abutments and piers
 - Place prestressing tendons and reinforcement in segments and at saddles
 - Cast all in-situ concrete in one casting
 - Prestress deck
- If the bearing tendons are required to run in ducts, the segments cannot be directly installed along them, requiring temporary cables and a trolley for segment installation.

Typical cross-section [Strasky 2004]

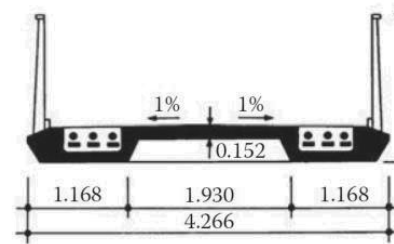

Lake Hodges Bikeway Access, San Diego, California, USA, T.Y. Lin and Jiri Strasky, 2009. Spans 3x100.58 m, deck thickness sag 1.41.m. Photo shp.com.