

2 In plane loading – walls and beams

2.3 Compatibility and deformation capacity

Learning objectives

Within this chapter, the students are able to:

- determine the behaviour of concrete as a function of the compressive strength and the cracking state.
- recognise the assumption of limit analysis methods for the materials having sufficient deformation capacity to reach the plastic solution without rupturing, and the existence of approaches to verify the deformation capacity of the materials.
- evaluate plastic redistributions of internal forces in hyperstatic systems (beams and frames) subjected either to external loads or imposed deformations, and calculate the deformation demand in elements subjected to bending or normal actions.
- estimate the deformation capacity of a structure subjected to bending or normal actions.
 - explain the tension-stiffening effect and how it affects the structural behaviour.
 - illustrate the main assumptions and behaviour of bonded reinforcement according to the Tension Chord Model.

2 In plane loading – walls and beams

2.3 Compatibility and deformation capacity

A) Behaviour of concrete in compression

Behaviour of concrete in compression

Main factors influencing the equivalent strength to be considered in plastic calculations

Strain softening after peak strength (material effect)

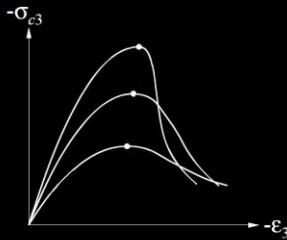

The concrete brittleness (i.e. relative amount of softening) increases with the compressive strength and also the reduction of the strength to be accounted for (η_{fc}).

$$f_{cd} = \frac{\eta_{fc} f_{ck}}{\gamma_c} \quad \eta_{fc} = \left(\frac{30}{f_{ck}} \right)^{1/3} \leq 1,0$$

Influence of transverse cracking on concrete strength (structural effect)

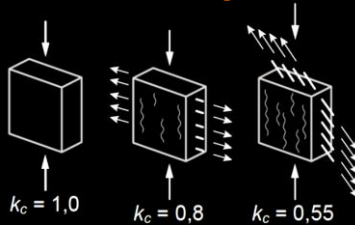

Reduction factor to account for this effect (k_c) can be determined in a more refined manner based on the state of deformations (see following slides).

Equivalent strength

$$k_c f_{cd} = k_c \frac{\eta_{fc} f_{ck}}{\gamma_c}$$

The compressive strength of concrete is typically measured in cylindrical specimens (1:2 aspect ratio) tested under uniaxial compression ($f_{c,cyl}$). For the sake of brevity, the cylindrical compressive strength of concrete $f_{c,cyl}$ will also be referred to in some chapters of the book (e.g. in the “Compatibility and deformation capacity of) as f'_c . The characteristic value (5% fractile) of $f_{c,cyl}$ is typically referred to as f_{ck} in structural concrete codes. The following two main aspects related to the stress-strain behaviour of the concrete should be considered when calculating the equivalent strength to be considered in plastic calculations from the measured cylindrical strength.

a) Strain softening after peak strength

In plastic analysis, the strain level of the material is not evaluated. Hence, the concrete might develop strain levels above that corresponding to the peak strength. Given that the concrete strength softens after reaching its peak, the peak compressive strength has to be reduced to be on the conservative side. This material effect is typically accounted for by the brittleness factor η_{fc} for concrete with characteristic compressive strength above 30 MPa. The concrete brittleness (i.e. the amount of softening) increases with the compressive strength and the reduction to be accounted for (e.g. no reduction for $f_{ck} = 30$ MPa; 20% reduction for $f_{ck} = 60$ MPa).

b) Influence of transverse cracking on concrete strength and stiffness

The effective compressive strength in each point depends on the existing state of transversal cracking (this effect is often called “compression softening”). Therefore, a different reduction factor should be applied to each point of the structure depending on the expected amount and opening of cracks (which are usually accounted for by means of the existing strains). This topic is addressed in detail in the following slides. The bottom figure shows typical values of the factor k_c to reduce the compressive strength. The value of k_c can be refined based on deformation considerations, as shown in the following slides.

Behaviour of concrete in compression

Dependence of the concrete compressive strength and shear resistance on the strain state

Tests have shown that the **compressive strength in membrane elements is reduced by (imposed) transverse strains**.

In 1986, Vecchio and Collins proposed reducing the compressive strength by a factor $1 / (0.8 + 170 \cdot \varepsilon_1) \leq 1$ (assuming "average" concrete stresses). This also takes implicitly other effects into account.

In 1998, Kaufmann proposed to consider additionally the (already known) inversely proportional increase of the compressive strength with the cylinder compressive strength:

$$f_{ce} = \frac{f_{c,cyl}^{2/3}}{0.4 + 30 \cdot \varepsilon_1}$$

On the basis of this and other work, SIA 262 has introduced the following coefficient for the verification of webs of beams:

$$k_c = \frac{1}{1.2 + 55\varepsilon_1} \leq 0.65$$

This can be applied in a more general way to any structural member when removing the 0.65 upper-bound

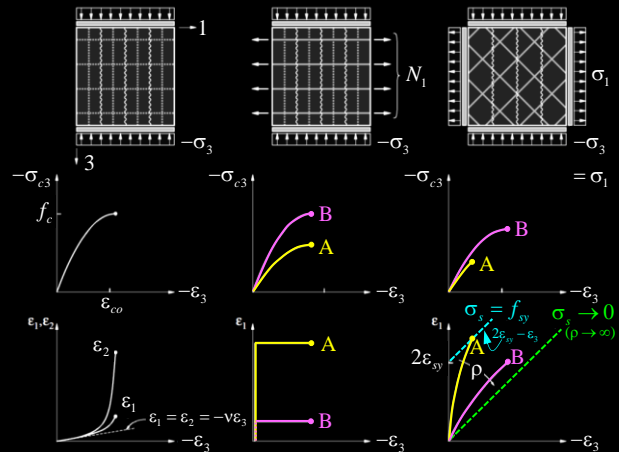

The reduction in compressive strength caused by imposed transversal strains is known as "compression softening". The hyperbolic relationship proposed by Vecchio and Collins is in good agreement with experimental data, although the relationship may also cover other types of failure, particularly in the case of large transverse strains (web crushing, sliding failures of cracks formed in earlier loading stages, rupture of stirrups). These phenomena are being further analysed currently at IBK.

The figures on the left show a pure compression test. At low loads, the behaviour is approximately linear elastic (Poisson's ratio ν). With increasing compressive stresses, the transversal strains increase much more; close to reaching its compressive strength, dilatancy (increase in volume) can be usually observed.

The figures in the middle show a compression test with imposed transversal strains (applied in the reinforcement). When small transversal strains are imposed, the uniaxial compressive strength is reached (or even exceeded); however, if a large transverse strain is imposed, a failure load lower than the uniaxial one is reached.

In compression-tension tests with inclined reinforcement (= shear) (figures on the right), a statement about the compressive strength can only be clearly made if concrete failure occurs without yielding of any of the reinforcements (case A); in this case, the compressive strength is in a similar range as in the case shown in the middle figures.

Behaviour of concrete in compression

Concrete compressive strength and shear resistance as a function of the strain state

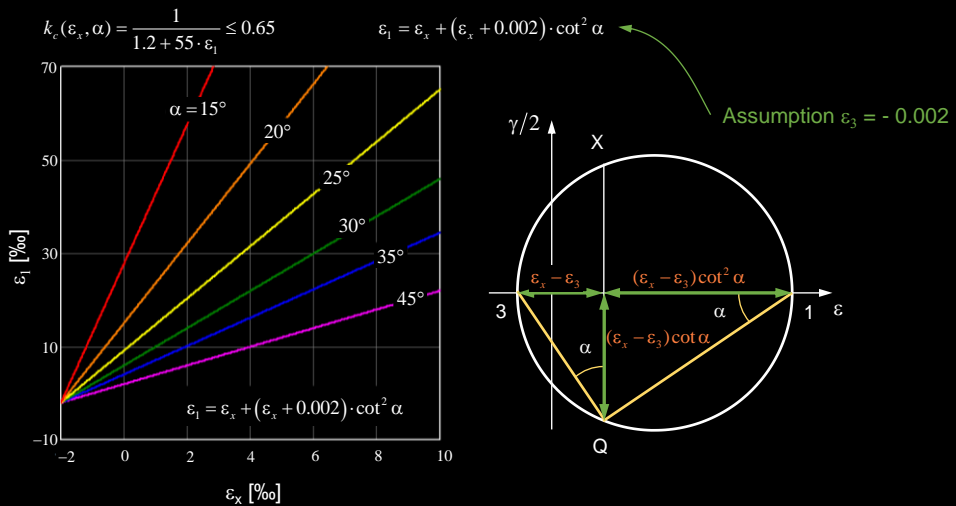

Concrete compressive strength as a function of the transversal strains

Assuming that the compressive ultimate strain of the concrete is constant (e.g. $\varepsilon_3 = -0.002$), the principal strain ε_1 is proportional to the longitudinal strain ε_x .

The longitudinal strain used for verifications is usually assumed to be the strain at the middle of the web height. This can be determined by performing a cross-sectional analysis (assuming Bernoulli's hypothesis that cross-sections remain plane) by applying the bending moment together with the maximum shear force; in principle, an additional normal force shall be applied to take into account the influence of the shear force on the chord forces.

Behaviour of concrete in compression

Concrete compressive strength and shear resistance as a function of the strain state

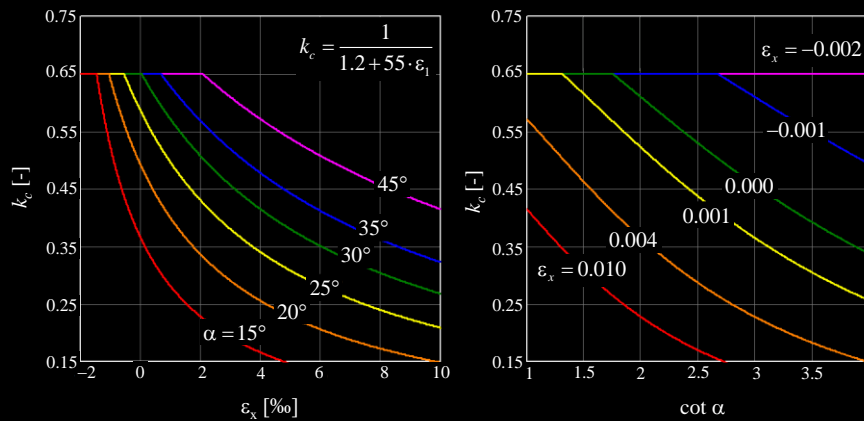

→ $k_c \cdot f_c$ is largely reduced for flat inclinations of the compression field and for plastic strains of the tension chord

For flat compressive field inclinations (small angles α), a smaller effective compressive strength in the web is obtained for k_c according to the relationship of SIA 262 (and also other similar relationships).

Both graphs show the same relationship. The graph on the left shows the value of k_c as a function of the longitudinal strain ε_x , taking the inclination of the compression field as a parameter. The right graph shows the value of k_c as a function of the inclination of the compression field ($\cot \alpha$), with the longitudinal strain ε_x as a parameter.

Behaviour of concrete in compression

Concrete compressive strength and shear resistance as a function of the strain state

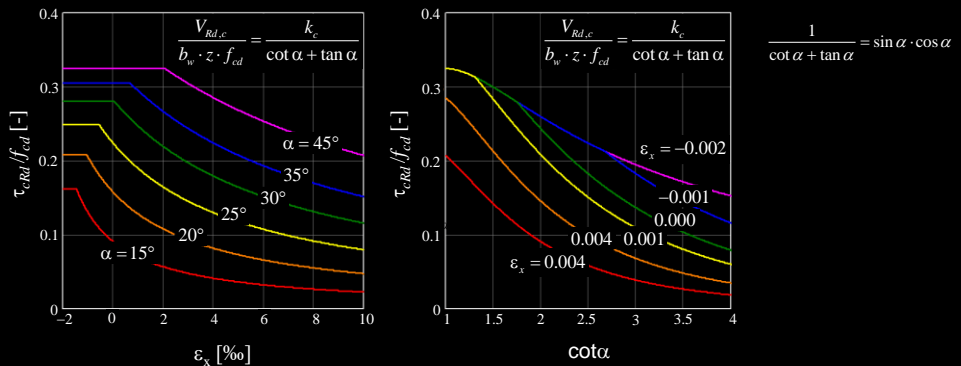

- $k_c \cdot f_c$ is largely reduced for flat inclinations of the compression field and for plastic strains of the tension chord
- Concrete compressive stresses increase sharply with flat inclinations (see above)
- Very flat inclinations do not make sense when dimensioning, but are often necessary when assessing old bridges
- Attention to plastic internal force redistributions from the support (= large shear force)

On the one hand, flat compression field inclinations (small angles α) result in greater compressive stresses in the web, but on the other hand, the compressive strength is reduced as a result of the transverse strains. Therefore, the shear resistance is significantly lower with flat inclinations than with steeper inclinations (maximum at $\alpha = 45^\circ$) (in the case that the concrete crushing failure is decisive).

Both graphs show the same relationship. The graph on the left shows the value of the "nominal shear resistance" $\tau_{Rd,c} = V_{Rd,c} / (z b_w)$, i.e. from $(\tau_{Rd,c} / f_{cd}) = V_{Rd,c} / (z b_w f_{cd})$ as a function of the longitudinal strain ϵ_x , in which the compressive strength f_{cd} is linked to ϵ_x and the compression field is a parameter. The right graph also shows the value of $(\tau_{Rd,c} / f_{cd}) = V_{Rd,c} / (z b_w f_{cd})$ represented as a function of the compression field inclination ($\cot \alpha$), with the longitudinal strain ϵ_x as a parameter.

It can be seen that for flat compression fields and large longitudinal strains, a very low shear strength is obtained. The expression $(\tau_{Rd,c} / f_{cd}) = V_{Rd,c} / (z b_w f_{cd})$ has a maximum value of $0.5 \cdot 0.65 = 0.325$ (upper limit of 0.65 for k_c applies, compressive field inclination $45^\circ \rightarrow$ compressive stress in the web is twice as large as the nominal shear stress $V / (z b_w)$).

2 In plane loading – walls and beams

2.3 Compatibility and deformation capacity

B) Behaviour of bonded reinforcement

Behaviour of the bonded reinforcement – Tension chord model (SBI)

Differential equations of bond

General bond-slip law

Equilibrium of an element with length dx :

$$\frac{d\sigma_c}{dx} = -\frac{\emptyset\pi\tau_b + q_x}{A_c(1-\rho)}; \quad \frac{d\sigma_s}{dx} = \frac{4\tau_b}{\emptyset}$$

→ ODE of 1st order

Considering linear elastic material behaviour:

$$\frac{d^2\delta}{dx^2} = \frac{4\tau_b}{\emptyset E_s} + \frac{\emptyset\pi\tau_b + q_x}{A_c E_c (1-\rho)}$$

→ ODE of 2nd order

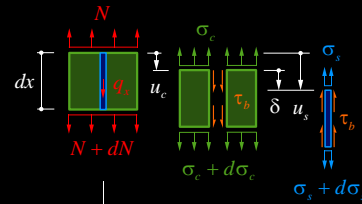

Simplified bond-slip law, used in TCM ———

Equilibrium of an element with length dx :

$$\frac{d\sigma_c}{dx} = -\frac{\emptyset\pi\tau_b + q_x}{A_c(1-\rho)} = \text{const}^*; \quad \frac{d\sigma_s}{dx} = \frac{4\tau_b}{\emptyset} = \text{const}^*$$

→ linear (integrate once)

Considering linear elastic material behaviour:

$$\frac{d^2\delta}{dx^2} = \frac{4\tau_b}{\emptyset E_s} + \frac{\emptyset\pi\tau_b + q_x}{A_c E_c (1-\rho)} = \text{const}^*$$

→ quadratic (integrate twice)

* if $q_x = \text{const}$

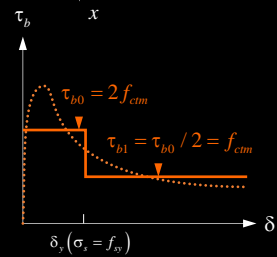

Repetition from Stahlbeton I: Tension chord model (TCM)

The differential equation of bond is derived from equilibrium of an infinitesimal element, considering linear elastic material behaviour. The slip is equivalent to the difference in the longitudinal

Behaviour of the bonded reinforcement – Tension chord model (SBI)

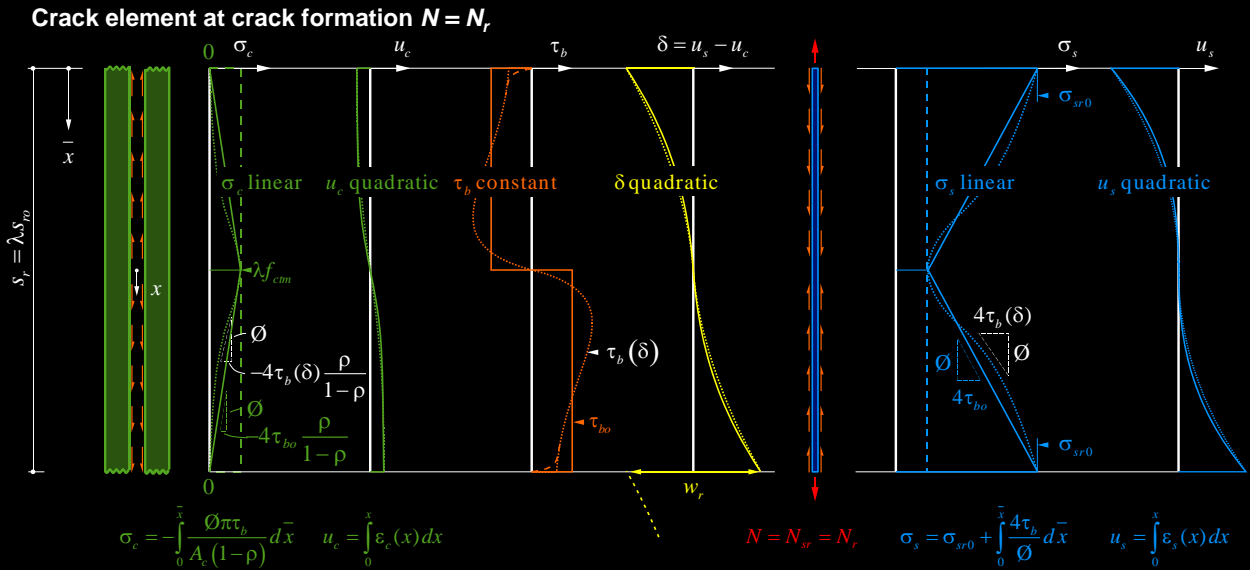

18.10.2023

ETH Zurich | Chair of Concrete Structures and Bridge Design | Advanced Structural Concrete

11

Repetition from Stahlbeton I: Tension chord model

When using the tension chord model (section-wise constant bond stresses) linear stress curves result. The deformations resulting from the strains due to simple integration are thus quadratic (with linear material behaviour).

Behaviour of the bonded reinforcement – Tension chord model (SBI)

View of a tension chord (total cross-section A_c), reinforced with bar with diameter \varnothing ([6], page 3.5f)

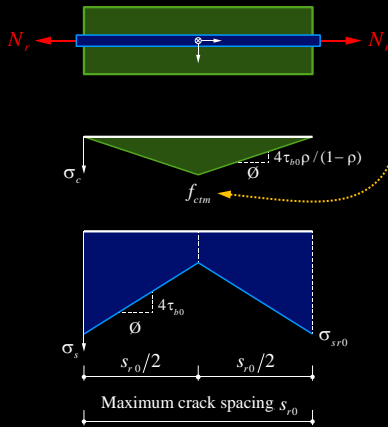

Concrete stress in the middle of the element with length s_{r0} (maximum crack spacing) is $\sigma_c = f_{ctm}$ i.e. another crack could form there.

$$s_{r0} \approx \frac{\varnothing}{4} \cdot \left(\frac{1}{\rho_t} - 1 \right)$$

Thus the minimum crack spacing is:

$$s_{r,min} = s_{r0}/2$$

Generally, the crack spacing varies with parameter λ :

$$s_r = \lambda \cdot s_{r0} \quad \left(\frac{1}{2} < \lambda < 1 \right)$$

→ Theoretical limits of the crack spacing with fully developed crack pattern!

SN: If the cracks form because of applied loads, the fully developed crack pattern forms at once (theoretically).

Repetition Stahlbeton I: Tension chord model

The tension chord model can be used to determine

- the maximum and minimum crack spacing
- the stresses in the reinforcement during crack formation and for loads exceeding the cracking load
- crack widths
- mean strains averaged over the length of the tension member (which are relevant for investigating the deformation capacity)

The crack spacing cannot be determined exactly. Instead, there is an uncertainty (factor 2) even under "ideal" conditions. In addition, there are various other uncertainties (e.g. scatter of concrete tensile strength and bond stress).

The influence of the crack spacing in the tension chord model is calculated with the parameter λ , which lies between $\lambda = 0.5$ (minimum theoretical crack spacing) and $\lambda = 1$ (maximum theoretical crack spacing).

The crack widths decrease with increasing amounts of reinforcement.

All deformation calculations, even with more complex models than the tension chord model, should, therefore, be regarded as approximations.

Behaviour of the bonded reinforcement – Tension chord model (SBI)

Increase of normal force after crack formation $N > N_r$ ([6], page 3.5f)

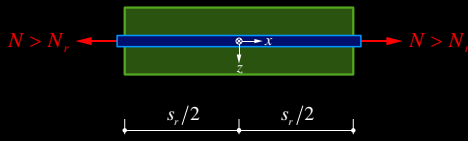

Concrete stresses remain constant after cracking.
Steel stresses continue raising.

Mean concrete elongation

$$\varepsilon_{cm} = \frac{\int_0^{s_r} \varepsilon_c dx}{s_r} = \frac{\int_0^{s_r} \frac{\sigma_c}{E_c} dx}{s_r} = \frac{\lambda f_{ctm}}{2E_c}$$

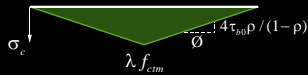

Concrete displacements

$$u_c(x) = \int_0^x \varepsilon_c(x) dx = \int_0^x \frac{\sigma_c(x)}{E_c} dx$$

$$u_{cr} = u_c \left(x = \frac{s_r}{2} \right)$$



Repetition Stahlbeton I: Tension chord model

The "mean concrete strains" (value averaged over the length of the crack element = elongation of the concrete over the crack element divided by the length of the cracked element) can be determined by simply integrating the linearly varying concrete strains.

The relative displacement of the crack surface corresponds to the integral of the concrete strains starting from the centre of the crack element up to the crack surface.

Behaviour of the bonded reinforcement – Tension chord model (SBI)

Increase of normal force after crack formation $N > N_r$ ([6], page 3.5f)

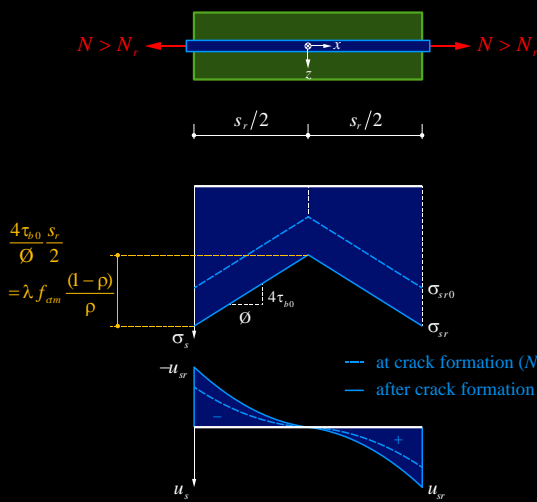

Concrete stresses remain constant after cracking.
Steel stresses keep increasing.

Mean steel elongation

$$\varepsilon_{sm} = \frac{\int_0^{s_r} \frac{\sigma_s}{E_s} dx}{s_r} = \frac{\sigma_{sr}}{E_s} - \frac{4\tau_{b0}}{\phi} \frac{s_r}{4E_s} = \frac{\sigma_{sr}}{E_s} - \frac{\lambda f_{ctm}(1-\rho)}{2\rho E_s}$$

Steel displacements

$$u_s(x) = \int_0^x \varepsilon_s(x) dx = \int_0^x \frac{\sigma_s(x)}{E_s} dx$$

$$u_{sr} = u_s\left(x = \frac{s_r}{2}\right)$$

Repetition Stahlbeton I: Tension chord model - Tension stiffening

The "mean steel strains" (value averaged over the length of the crack element = elongation of the reinforcing steel over the crack element divided by the length of the crack element) can be determined by simply integrating the linearly varying steel strains.

The elongation of the tension chord (averaged over the crack element) corresponds to the elongation of the reinforcing steel. The "average elongation" of the tension chord thus corresponds to the average steel elongation.

It can be seen that the mean elongation of the tension chord before yielding of the reinforcement corresponds to that of the bare reinforcement minus a constant term (see also next slide).

Behaviour of the bonded reinforcement – Tension chord model (SBI)

Increase of normal force after crack formation $N > N_r$ ([6], page 3.5f)

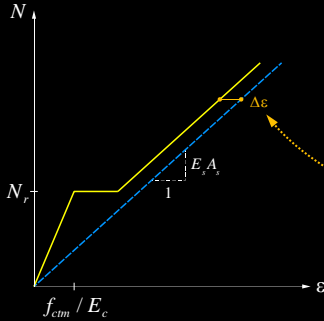

N - ϵ - and σ_s - ϵ -diagrams : Reduction of the elongation of the bare steel by $\Delta\epsilon$ ($\Delta\epsilon$ remains constant until yielding).

NB: Good approximation for w_r (small ρ)

$$\frac{\phi/4\rho}{2E_s} \left(\frac{N}{A_s} - \frac{f_{ctm}}{4\rho} \right) \leq w_r \leq \frac{\phi/4\rho}{E_s} \left(\frac{N}{A_s} - \frac{f_{ctm}}{2\rho} \right)$$

Concrete stresses remain constant after cracking. Steel stresses keep increasing.

Steel elongation at crack

$$\epsilon_{sr} = \sigma_{sr} / E_s$$

Average concrete elongation

$$\epsilon_{cm} = \lambda f_{ctm} / (2E_c)$$

Mean steel elongation

$$\epsilon_{sm} = \frac{\sigma_{sr}}{E_s} - \frac{\tau_{b0} s_r}{\phi E_s} = \frac{\sigma_{sr}}{E_s} - \frac{\lambda f_{ctm} (1 - \rho)}{2\rho E_s}$$

Crack widths: Difference of the mean steel and concrete strains multiplied by s_r ($\lambda = 0.5 \dots 1$):

$$w_r = s_r \left[\frac{\sigma_{sr}}{E_s} - \frac{\lambda f_{ctm} (1 - \rho)}{2\rho E_s} - \frac{\lambda f_{ctm}}{2E_c} \right] = \frac{\lambda s_{r0} (2\sigma_{sr} - \lambda \sigma_{sr0})}{2E_s}$$

with $\sigma_{sr} = N / A_s$

$$\frac{s_{r0}}{2E_s} \left(\sigma_{sr} - \frac{\sigma_{sr0}}{4} \right) \leq w_r \leq \frac{s_{r0}}{E_s} \left(\sigma_{sr} - \frac{\sigma_{sr0}}{2} \right)$$

Repetition Stahlbeton I: Tension chord model – Tension stiffening

The mean elongation of the tension chord before the onset of yielding corresponds to the mean elongation of the bare reinforcement minus a constant term $\Delta\epsilon$. After the onset of yielding at the cracks, the term $\Delta\epsilon$ increases until the reinforcement yields over the entire crack element, after which it remains constant again.

Behaviour of the bonded reinforcement – Tension chord model (SBI)

Crack element at crack formation $N_y \leq N \leq N_u$

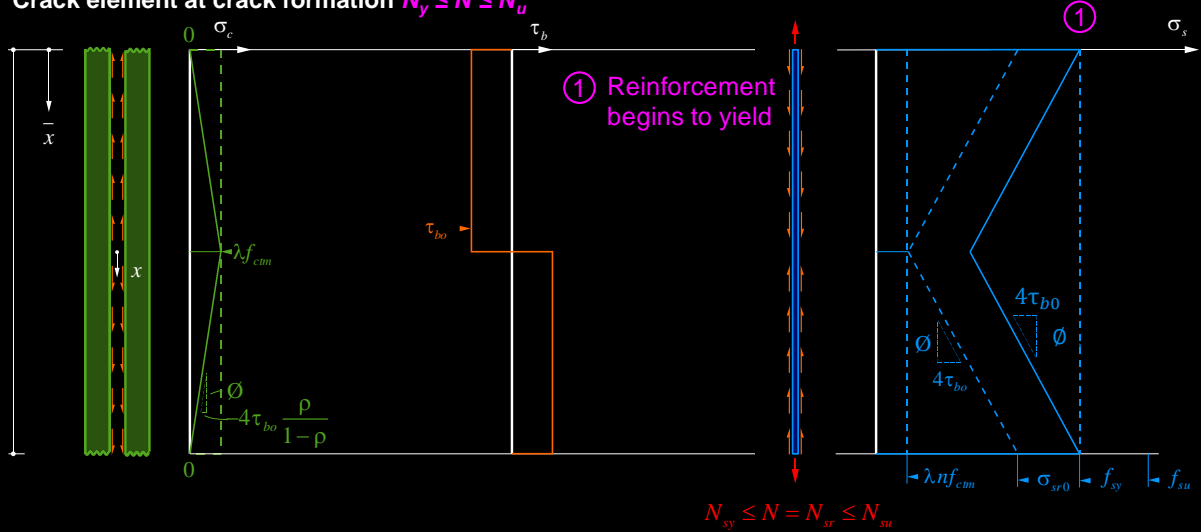

Repetition from Stahlbeton I: Tension chord model

Tension stiffening has a detrimental effect on ductility. To assess ductility, a hardening of the reinforcing steel must be taken into account. As a simplification, a bilinear material law is used here.

Behaviour of the bonded reinforcement – Tension chord model (SBI)

Crack element at crack formation $N_y \leq N \leq N_u$

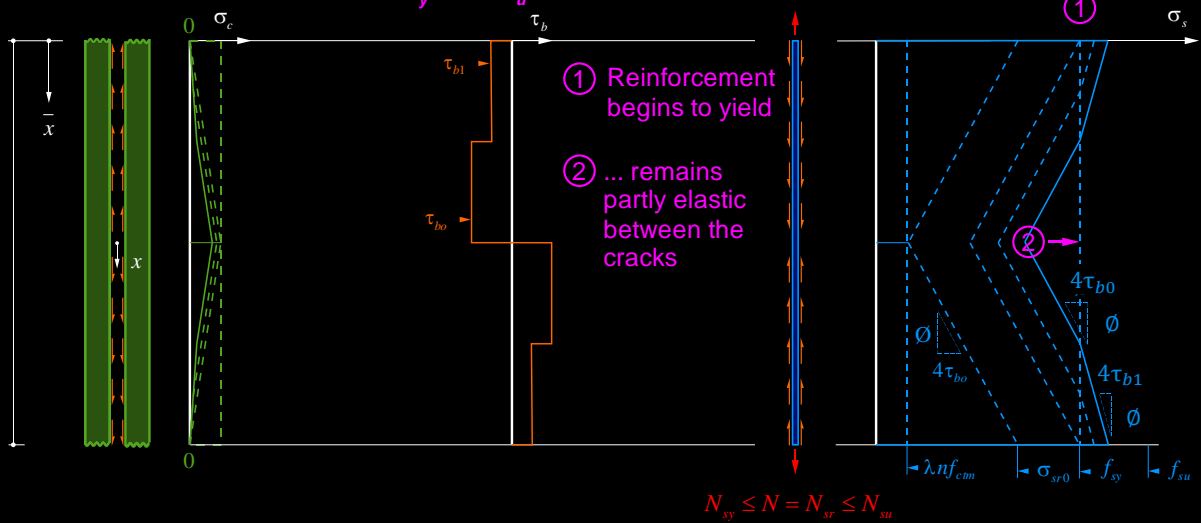

Repetition from Stahlbeton I: Tension chord model

After the yield strength of the reinforcement has been exceeded, the bond shear stress decreases to half of the initial value according to the tension chord model. Since the yield stress is reached first in the cracks, the areas with reduced bond stress spread successively from the cracks towards the centre. In the partially yielded crack element, the reinforcement yields near the crack (but in between, it is still elastic). The relations for the mean strains as a function of the steel stress at the crack (and vice versa) are more complicated in this regime than for the elastic behaviour regime.

Behaviour of the bonded reinforcement – Tension chord model (SBI)

Crack element at crack formation $N_y \leq N \leq N_u$

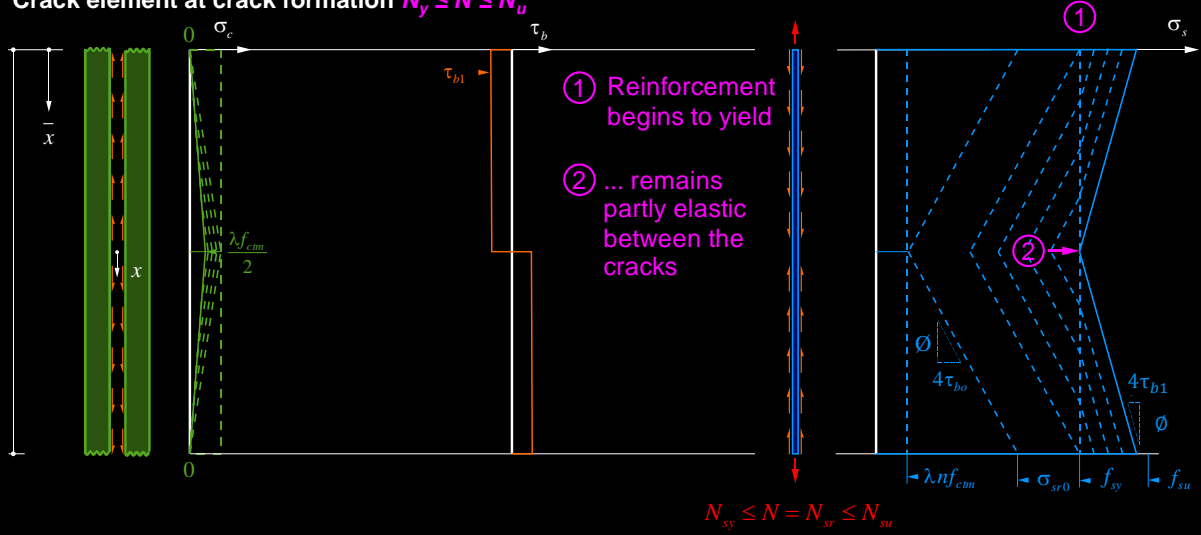

Behaviour of the bonded reinforcement – Tension chord model (SBI)

Crack element at crack formation $N_y \leq N \leq N_u$

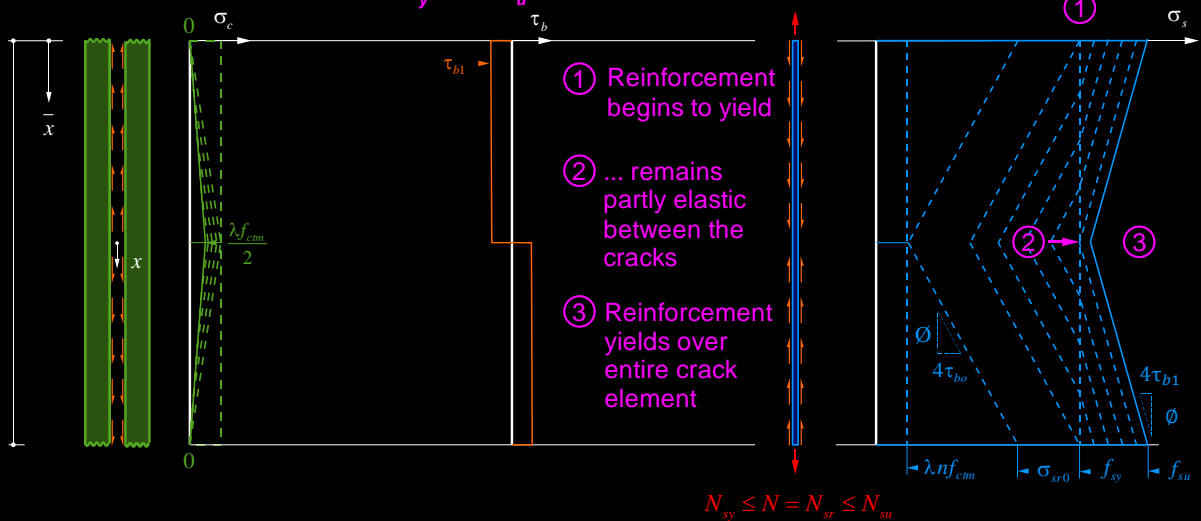

18.10.2023

ETH Zurich | Chair of Concrete Structures and Bridge Design | Advanced Structural Concrete

19

Repetition from Stahlbeton I: Tension chord model

At a certain load, the reinforcement yields over the entire crack element (fully yielded crack element). The relations for the mean strains in function of the steel stress at the crack (and vice versa) in this regime are analogous to those in the elastic range, just with a reduced bond stress (and E_{sn} instead of E_s).

Additional remarks

- It would be possible to consider different stress-strain relationships of the reinforcement. In view of the further simplifications (stress-free, rotating cracks), however, only a bilinear material relationship is used.
- The bond stresses, according to the TCM, depend only on the stress state of the reinforcement. However, they are independent of the bond slip. This is particularly useful in membrane elements since the calculation of slip and the simultaneous (numerical) solution of the second order bond-slip differential equations in both reinforcement directions would require a great deal of computational effort.

Behaviour of the bonded reinforcement – Tension chord model (SBI)

Closed form solution for a bilinear steel stress-strain relationship

① Elastic reinforcement over entire crack element

$$\sigma_{sr} \leq f_{sy}$$

$$\sigma_{sr} = E_s \varepsilon_m + \frac{\tau_{b0} s_r}{\varnothing}$$

$$\varepsilon_m = \frac{\sigma_{sr}}{E_s} - \frac{\tau_{b0} s_r}{E_s \varnothing} = \frac{\sigma_{sr}}{E_s} - \lambda \frac{f_{ctm} (1-\rho)}{2E_s \rho}$$

"bare steel – $\Delta\varepsilon_0$ "

$$\Delta\varepsilon_0 = \frac{\tau_{b0} s_r}{E_s \varnothing} = \lambda \frac{f_{ctm} (1-\rho)}{2E_s \rho}$$

② Reinforcement yields near cracks, elastic between cracks

$$f_{sy} \leq \sigma_{sr} \leq \left(f_{sy} + \frac{2\tau_{b1} s_r}{\varnothing} \right)$$

$$\sigma_{sr} = f_{sy} + 2 \frac{\tau_{b0} s_r}{\varnothing} - \sqrt{\left(f_{sy} - E_s \varepsilon_m \right) \frac{\tau_{b1} s_r}{\varnothing} \left(\frac{\tau_{b0}}{\tau_{b1}} - \frac{E_s}{E_{sh}} \right) + \frac{E_s}{E_{sh}} \tau_{b0} \tau_{b1} \frac{s_r^2}{\varnothing^2}}$$

$$\varepsilon_m = \frac{(\sigma_{sr} - f_{sy})^2 \varnothing}{4E_{sh} \tau_{b1} s_r} \left(1 - \frac{E_{sh} \tau_{b0}}{E_s \tau_{b1}} \right) + \frac{(\sigma_{sr} - f_{sy})}{E_s} \frac{\tau_{b0}}{\tau_{b1}} + \left(\varepsilon_{sy} - \frac{\tau_{b0} s_r}{E_s \varnothing} \right)$$

③ Reinforcement yields over entire crack element

$$\left(f_{sy} + \frac{2\tau_{b1} s_r}{\varnothing} \right) \leq \sigma_{sr} \leq f_{su}$$

$$\sigma_{sr} = f_{sy} + E_{sh} \left(\varepsilon_m - \frac{f_{sy}}{E_s} \right) + \frac{\tau_{b1} s_r}{\varnothing}$$

$$\varepsilon_m = \varepsilon_{sy} + \frac{(\sigma_{sr} - f_{sy})}{E_{sh}} - \frac{\tau_{b1} s_r}{E_{sh} \varnothing}$$

"bare steel – $\Delta\varepsilon_1$ "

$$\Delta\varepsilon_1 = \frac{\tau_{b1} s_r}{E_{sh} \varnothing}$$

Relationships for the steel stresses at the crack as a function of the average strains can be formulated in closed form. In the slide, the relationships are given for a bilinear steel stress-strain relationship of the reinforcement.

Additional remark

- For low stress levels, these equations - which require slip over the entire length of the crack element - result in an overestimated stress in the reinforcement or compressive stresses in the middle between the cracks for a given crack spacing (which follows per reinforcement direction from the diagonal crack spacing and the crack inclination). Correspondingly corrected relationships for the steel stresses at the crack can also be formulated analytically. They essentially correspond to the behaviour in a pull-out test in which the slip propagates with increasing load starting from the crack towards the crack element centre. These relationships will not be discussed further here.

Behaviour of the bonded reinforcement – Tension chord model (SBI)

Constitutive relationship of the bonded reinforcement (tension chord model with bilinear bare reinforcement):

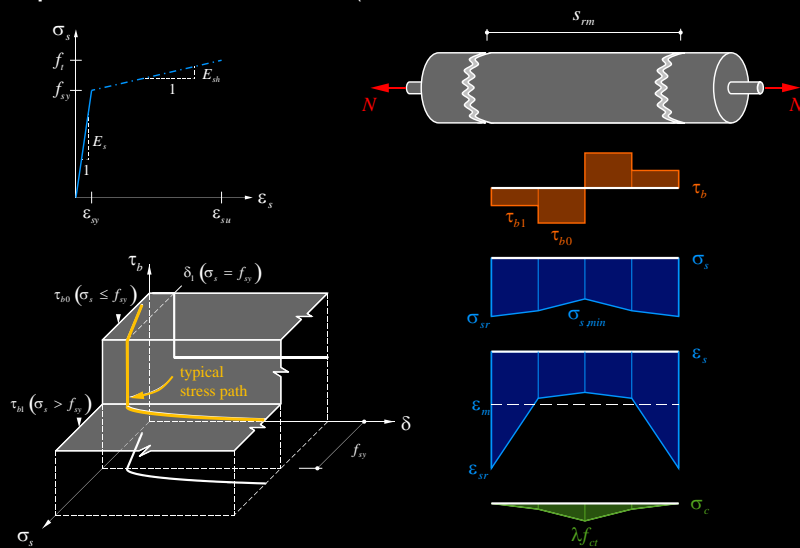

Repetition Stahlbeton I: Tension chord model

The figure shows the same information as the previous slides, in a slightly different representation, for the partially yielded regime.

In addition to the steel stresses, the steel strains are also given (approximately to scale). One can see that, although the steel stresses vary less strongly near the cracks, the steel strains in the area where the reinforcement yields (near the crack) increase much more. Most of the elongation of the tensile member is, therefore, caused by these strains. This is because the stiffness of the reinforcement drops drastically after the onset of yielding (hardening modulus is much smaller than the modulus of elasticity).

Behaviour of the bonded reinforcement – Tension chord model (SBI)

Load-deformation behaviour considering bond
(influence at high loads)

- No influence on tensile resistance
- Stiffer behaviour than bare steel

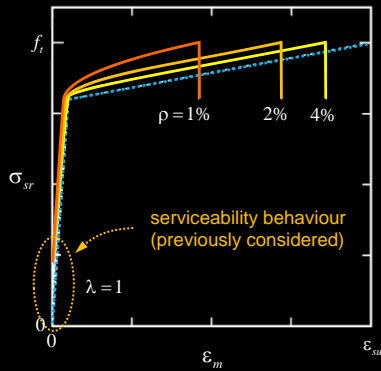

Ratio of average elongation to maximum elongation at
the cracks considering bond

- Heavy drop after onset of yielding
- Pronounced influence on ductility!

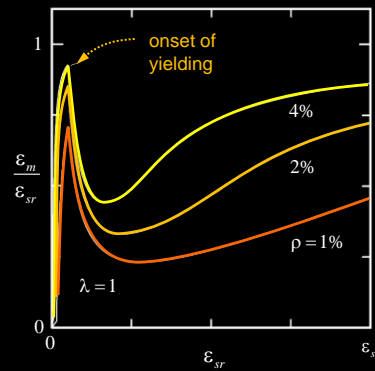

$f_s = 500 \text{ MPa}$
 $f_{su} = 625 \text{ MPa}$
 $E_s = 200 \text{ GPa}$
 $\epsilon_{su} = 0.05$
 $\varnothing = 16 \text{ mm}$
 $f_c = 30 \text{ MPa}$

18.10.2023

ETH Zurich | Chair of Concrete Structures and Bridge Design | Advanced Structural Concrete

22

Repetition Stahlbeton I: Tension chord model – Ductility

The figure illustrates the reduction of ductility caused by the tension-stiffening effect. Although the calculations were carried out for relatively ductile reinforcement and large reinforcement ratios, the influence is impressive.

The value $\epsilon_{sm}/\epsilon_{sr}$ shown on the right measures the extent to which the ductility of the bare reinforcing steel is reduced by bond.

Behaviour of the bonded reinforcement

Application to loading cases different than uniaxial tension

Simple bending (SB I): Elastic bending stiffness – tensile stiffness [6], page 2.16f

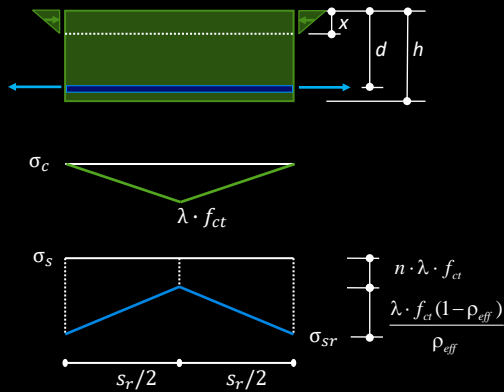

Setting the steel stress at the crack at the onset of cracking ($M = M_r$)

$$\sigma_{sr0} = \frac{M_r}{A_s(d-x/3)} = \frac{M_r(d-x)E_s}{EI''} \quad \text{mit } EI'' = A_s E_s (d-x)(d-x/3)$$

equal to the steel stress at cracking of a tension chord

$$\sigma_{sr0} = f_{ct} \left(\frac{1}{\rho_{eff}} + n - 1 \right)$$

one obtains the equivalent reinforcement ratio ρ_{eff} :

$$\rho_{eff} = \frac{1}{\frac{M_r(d-x)E_s}{f_{ct}EI''} + 1 - n}$$

For loading cases different from uniaxial tension, a fictitious reinforcement ratio that provides in uniaxial tension a similar behaviour as the real tensile behaviour of the structural element should be calculated so that the relationship of the tension chord model can be applied. The slide shows a simple approach to calculate this equivalent reinforcement ratio for the case of simple bending (**repetition from Stahlbeton I**). However, there are no consistent approaches to calculate the equivalent reinforcement ratio for more complex conditions. In the chapter about numerical modelling, an approximate but general procedure to compute this equivalent ratio based on empirical recommendation will be discussed. This method is used in the Compatible Stress Field Method.

Behaviour of the bonded reinforcement

Tension stiffening for non-stabilised crack patterns (pull-out model)

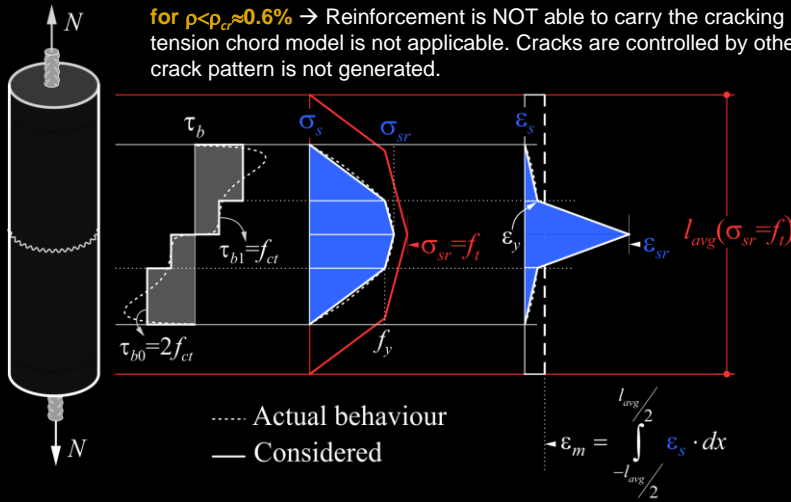

- A pull-out tension stiffening model can be formulated for these situations by assuming (a) independent cracks and (b) the same bond slip model as for the tension chord model.
- A certain crack spacing (l_{avg}) should be assumed to compute the average reinforcement strain.

In low reinforced regions (with geometric reinforcement ratios lower than ρ_{cr} , i.e. the minimum reinforcement amount for which the reinforcement is able to carry the cracking load without yielding) and for low loads, the cracking might be non-stabilised. The tension chord model is not applicable in such cases as it assumes a fully developed crack pattern. For these regions, the pull-out tension stiffening model described in the figure can be used. This model analyses the behaviour of a single crack by (i) considering no mechanical interaction between separate cracks, (ii) neglecting the deformability of concrete in tension, and (iii) assuming the same stepped, rigid-perfectly plastic bond shear stress-slip relationship used by the tension chord model. Given that the crack spacing is unknown for a non-fully developed crack pattern, a certain averaging length (l_{avg} in the figure) should be assumed to compute the average strain of the reinforcement.

2 In plane loading – walls and beams

2.3 Compatibility and deformation capacity

C) Deformation capacity of beams

Beams – Deformation capacity

Limitation of the compression zone depth according to SIA 262

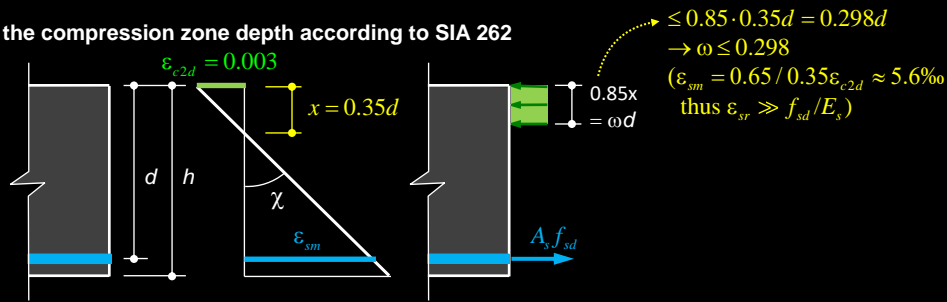

Maximum reinforcement ratio and bending resistance according to SIA 262, section 4.1.4.2: (for components mainly subjected to bending)

- $x/d \leq 0.35$: Internal force redistributions **without** verification of deformation capacity
 $x/d \leq 0.35 \rightarrow \omega \leq 0.298 \rightarrow M_{Rd} \leq bd^2 f_{cd} \omega \cdot (1 - \omega/2) = 0.253 \cdot bd^2 f_{cd}$

Repetition of Stahlbeton I:

Bending: According to standard SIA 262, internal forces of beams may be redistributed without verification of the deformation capacity, provided that the compression zone depth is limited to $x/d \leq 0.35$. Compression zone depths $x/d > 0.5$ are to be avoided. Extract from the standard:

- 4.1.4.2.4 A ductile behaviour must be ensured through detailing measures (e.g. confinement of the flexural compression zone), the choice of material properties and the provision of a minimum reinforcement.
- 4.1.4.2.5 Internal forces and moments of statically indeterminate structural members primarily subjected to bending which are determined according to Section 4.1.4.1, may be redistributed while satisfying the equilibrium conditions and complying with Section 4.1.4.2.4 without verification of the deformation capacity, if:
- the depth of the compression zone does not exceed the value $x/d = 0.35 \cdot 435 / f_{sd}$
 - for flat slabs, the slab rotation ψ according to equation (59) is greater than 0.020
 - reinforcing steel classes B or C and concrete of classes $\leq C50/60$.

The idealisation according to section 4.2.1 apply for the determination of the compression zone depth x ; any compression zone reinforcement may be taken into account.

- 4.1.4.2.6 If the conditions of Section 4.1.4.2.5 are not fulfilled, **a verification of the plastic deformation capacity has to be provided**. Both values $x/d > 0.5 \cdot 435 / f_{sd}$ in bending and $\psi < 0.008$ in flat slabs shall be avoided if possible in any case.

Beams – Deformation capacity

Limitation of the compression zone depth according to SIA 262

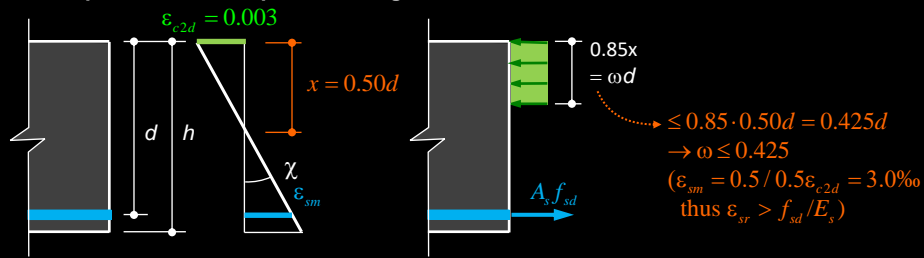

Maximum reinforcement ratio and bending resistance according to SIA 262, section 4.1.4.2:
(for components mainly subjected to bending)

- $0.35 \leq x/d \leq 0.5$: Internal force redistributions **with** verification of deformation capacity
 $x/d \leq 0.50 \rightarrow \omega \leq 0.425 \rightarrow M_{Rd} \leq bd^2 f_{cd} \omega \cdot (1 - \omega/2) = 0.335 \cdot bd^2 f_{cd}$

Additional remarks:

- The minimum beam depth required for compliance with the condition x/d can be determined from the applied M_{Rd} .
- The compression zone depth can be reduced, and the deformation capacity increased with confining or compression reinforcement.
- If compression reinforcement is provided, special attention must be paid to the workability (several layers of compressive reinforcement make it difficult to place and compact the concrete); if the concrete cannot be compacted properly, compression reinforcement is counterproductive. If several layers of compression reinforcement are required, it is beneficial to align the bars in vertical planes (leaving space for vibrating needles between them).
- Reinforcement of strength class B700B can also be used as compressive reinforcement, especially when space is limited.

Beams – Deformation capacity

Limitation of the compression zone depth according to SIA 262

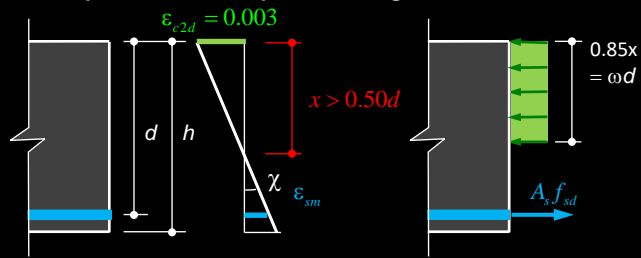

Maximum reinforcement ratio and bending resistance according to SIA 262, section 4.1.4.2:
(for components mainly subjected to bending)

- $x/d > 0.50$: is to be avoided

Beams – Deformation capacity

Limitation of the compression zone depth according to SIA 262

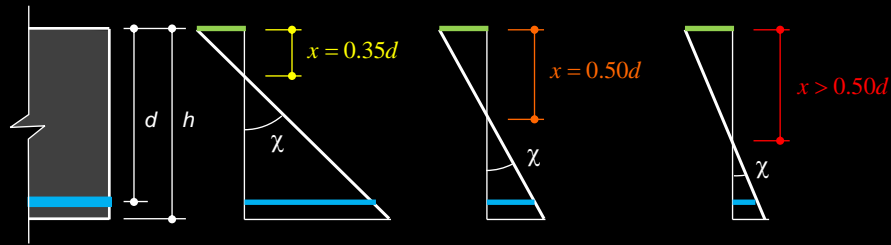

Maximum reinforcement ratio and bending resistance according to SIA 262, section 4.1.4.2:
(for components mainly subjected to bending)

- $x/d \leq 0.35$: Internal force redistributions **without** verification of deformation capacity
 $x/d \leq 0.35 \rightarrow \omega \leq 0.298 \rightarrow M_{Rd} \leq bd^2 f_{cd} \omega \cdot (1 - \omega/2) = 0.253 \cdot bd^2 f_{cd}$
- $0.35 \leq x/d \leq 0.5$: Internal force redistributions **with** verification of deformation capacity
 $x/d \leq 0.50 \rightarrow \omega \leq 0.425 \rightarrow M_{Rd} \leq bd^2 f_{cd} \omega \cdot (1 - \omega/2) = 0.335 \cdot bd^2 f_{cd}$
- $x/d > 0.50$: **is to be avoided**

Beams – Deformation capacity

Limitation of the compression zone depth according to SIA 262

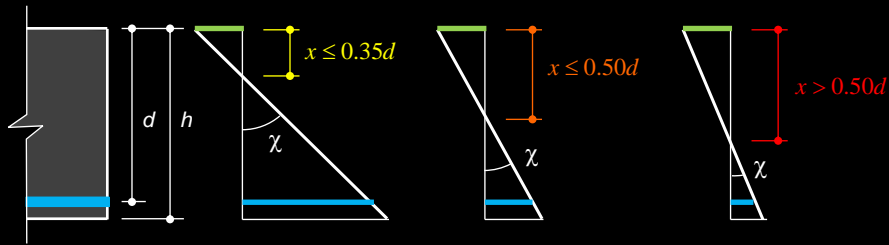

Maximum reinforcement ratio and bending resistance according to SIA 262, section 4.1.4.2:
(for components mainly subjected to bending)

- $0.35 \leq x/d \leq 0.5$: Internal force redistributions **with** verification of deformation capacity

As already stated, the verification of the plastic deformation capacity is only an approximation, even if relatively complex investigations are carried out.
A possible procedure is explained on the following slides.

Beams – Deformation capacity

System behaviour
(see also [6], page 2.32ff)

Continuous increase of the load q :

- Yielding begins first at the fixed-end support, forming a plastic hinge
- The statically indeterminate system turns (for additional loading) into a simple beam

Further load increase is possible until a second plastic hinge is formed in the member (= mechanism):

- Plastic rotation required at the fixed support
- **Rotation demand** depending on static system and load configuration
- **Rotation capacity** limited by steel elongation and / or concrete compression

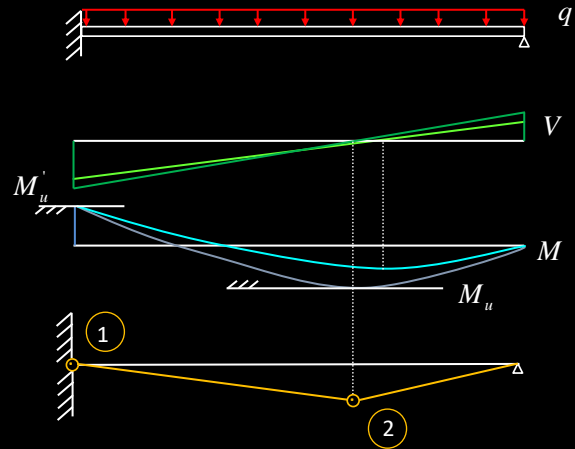

Verification = Comparison:
Deformation capacity $\Theta_{pu} \leftrightarrow$ Deformation demand $\Theta_{pu, dem}$

Repetition from Structural Analysis (Baustatik):

When determining the load-bearing capacity of statically indeterminate, perfectly plastic systems, it is generally assumed that there are no initial residual stresses and that the structure initially behaves elastically. As soon as the bending resistance is reached in a cross-section, a plastic hinge is formed and the moment in the plastic hinge remains constant for further load increase. With each plastic hinge, the degree of static indeterminacy is reduced until a statically determined system is reached. If another plastic hinge is formed, the ultimate load is reached and a failure mechanism is formed.

The **deformation demand** (rotation demand) can be determined by the plastic rotations in the plastic hinges (after the bending resistance is reached in the corresponding cross-section).

In order to verify if the plastic deformation capacity is sufficient, the deformation demand shall be compared to the **deformation capacity** (rotational capacity).

Beams – Deformation capacity

Rotation demand $\Theta_{pu, dem}$ (approximation, example two-span beam)

In general, deformation capacity and deformation demand are coupled.

The interaction can only be neglected for moderate redistributions.

Additional simplifications:

- Constant bending stiffness
- $M-\Theta$ rigid-ideal plastic (no hardening in the plastic hinge)

Therefore, the rotation demand $\Theta_{pu, dem}$ of the intermediate support corresponds to the relative rotation of the two beams over the intermediate support, which can be considered as simply supported beams after reaching M_{ay} (at $q = q_y$):

$$\Theta_{pu, dem} = \frac{(q - q_y) l^3}{12EI}$$

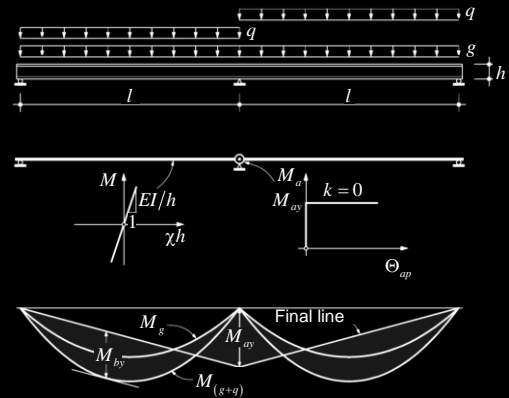

(Two-span beam, first plastic hinge at intermediate support, deformation demand for full load)

The obtained angles in the plastic hinges for statically indeterminate systems are dependent on the deformations of the system and on the redistributions of the internal forces. Therefore, a separate treatment of the deformation capacity and the deformation demand is generally not possible. For moderate redistributions of internal forces, however, this interaction can be neglected.

In the following, the deformation capacity is examined independently of the deformation demand. To determine the deformation demand, it is assumed that the plastic hinges behave perfectly plastic (no hardening). It should be noted that this contradicts the bilinear material relationship (with hardening) of the reinforcement used to determine the deformation capacity. This greatly simplifies the calculations and is admissible considering that the deformation capacity and deformation demand are investigated separately.

In order to obtain reliable results, the influence of crack formation needs to be taken into account when determining the stresses. The behaviour is, therefore, nonlinear even before the formation of the first plastic hinge. It can be assumed that the behaviour (state II) is cracked-elastic (over the entire beam length) and thus, the bending stiffness is constant. This is particularly admissible since the crack formation after the occurrence of plastic deformations has only a minor effect on the internal force redistribution.

The considered conditions are greatly simplified with the decoupled analysis of the deformation capacity and the deformation demand. Nevertheless, useful approximations can be found, at least for usual beam dimensions and reinforcement arrangements.

Beams – Deformation capacity

Rotation demand - Example of a two-span beam

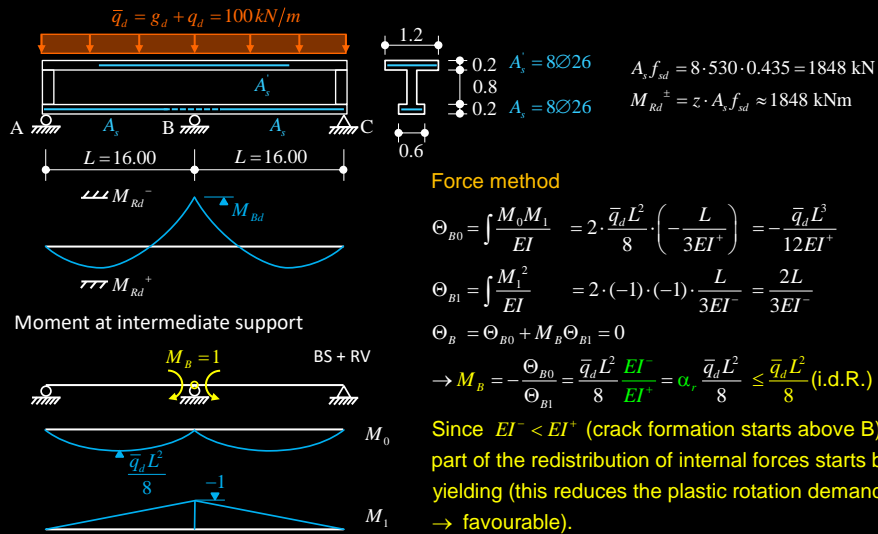

The investigation of the deformation capacity is illustrated by the example of the two-span beam shown in the figure.

In a first step, the elastic internal force distribution of the system is determined (once statically indeterminate beam, force method). The influence of crack formation on stiffness (especially positive / negative bending stiffness) can be taken into account. The deformations due to shear forces are neglected, as usual in beam statics.

Beams – Deformation capacity

Rotation demand - Example of a two-span beam

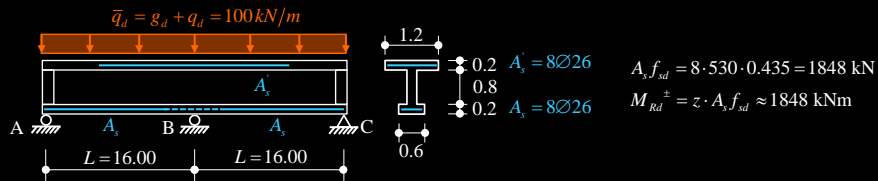

EI'' (cracked)

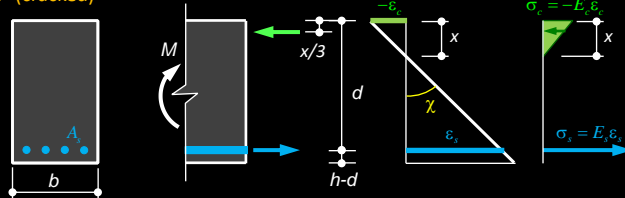

$$M = A_s E_s \epsilon_s \left(d - \frac{x}{3} \right), \quad \gamma = \frac{\epsilon_s}{d-x} = \frac{M}{EI''} \quad (\text{here for simplicity } \epsilon_{sm} = \epsilon_{sr} \text{ is assumed, with } \epsilon_{sm} < \epsilon_{sr} \text{ a smaller rotation demand results})$$

$$\rightarrow EI'' = \frac{M}{\gamma} = A_s E_s \underbrace{\left(d - \frac{x}{3} \right)}_{\approx z} \underbrace{(d-x)}_{\approx 0.9z} \approx 0.9 A_s E_s z^2 = 0.9 \cdot 4240 \cdot 205'000 \cdot 1^2 = 780 \text{ MNm}^2 \quad (EI'_I = 3502 \text{ MNm}^2)$$

The calculation is made with the bending stiffness of state II (cracked-elastic). This is slightly more than 22% of the uncracked bending stiffness.

Beams – Deformation capacity

Rotation demand - Example of a two-span beam

Yielding

$$\alpha_r \frac{\bar{q}_d L^2}{8} = M_{Rd}^- \rightarrow \bar{q}_{dy} = \frac{8M_{Rd}^-}{\alpha_r L^2} = \frac{1}{\alpha_r} \frac{8 \cdot 1848}{256}$$

$$= \frac{1}{\alpha_r} 57.8 \text{ kNm}^{-1}$$

$$\rightarrow \bar{q}_d - \bar{q}_{dy} = 100 - \frac{1}{\alpha_r} 57.8 \text{ kNm}^{-1} = 42.2 \text{ kNm}^{-1} \quad (\alpha_r = 1.0)$$

$$= 27.8 \text{ kNm}^{-1} \quad (\alpha_r = 0.8)$$

$$\Theta_{B,dem} = (\bar{q}_d - \bar{q}_{dy}) \frac{L^3}{12EI} = \frac{42.2 \cdot 16^3}{12 \cdot 780 \cdot 10^3} \frac{\text{kNm}^2}{\text{kNm}^2}$$

$$= 18.5 \text{ mrad} \quad (\alpha_r = 1)$$

$$= 12.2 \text{ mrad} \quad (\alpha_r = 0.8)$$

After reaching M_{Rd}^- :

Two simply supported beams for additional loading $\bar{q}_d - \bar{q}_{dy}$ with the corresponding relative rotation of the beam ends at B (see BS+RV in slide 33)

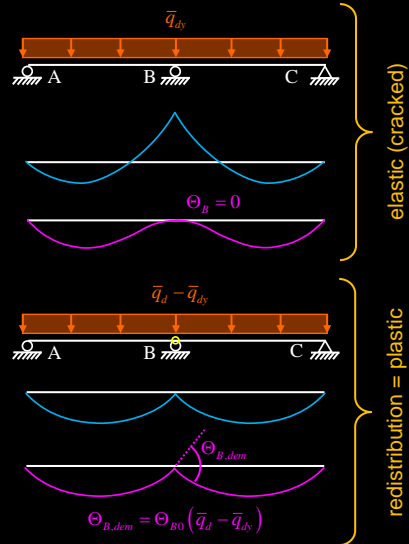

The rotation demand corresponds to the relative rotation in the plastic hinge after the bending resistance is reached.

The system (based on the assumption that the plastic hinge does not show any hardening) acts as two simply supported beams from this point. The relative rotation can easily be determined from the end rotation of the two single span beams under the additional load applied after the formation of the plastic hinge.

Beams – Deformation capacity

Rotation capacity Θ_{pu} – Basics

Example: Plastic hinge angle as a function of ω (ductility classes A-C, 1999)

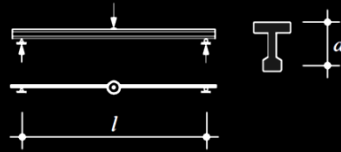
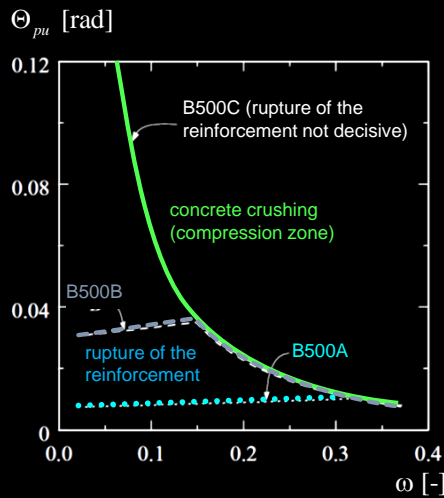

Basis of the calculations:

$$\begin{aligned}
 f_y &= 500 \text{ MPa} & l/d &= 20 \\
 E_s &= 200 \text{ GPa} & \theta &= 45^\circ \\
 f_c &= 30 \text{ MPa} & \varnothing &= 20 \text{ mm} \\
 \varepsilon_{cu} &= 5 \text{ ‰} & s_{rm} &= 150 \text{ mm}
 \end{aligned}$$

The deformation capacity (rotational capacity) of a beam is limited by the following types of failure:

- Crushing of the compression zone (concrete failure)
- Rupture of the reinforcement (steel rupture).

The governing factor is which type of failure occurs first (with smaller rotation).

The diagram impressively illustrates that when using a low ductility reinforcement (B500A) there is a very small rotational capacity. In many cases (e.g. for $x/d < 0.17$), the rupture of the reinforcement is also decisive with reinforcing steel B500B.

Beams – Deformation capacity

Rotation capacity Θ_{pu} (simplified) (see also [6], page 2.32ff)

Limitation of the plastic rotation by the reinforcing steel (rupture of the reinforcement):

$$\Theta_{pus} = L_{pl} \cdot \left(\frac{\varepsilon_{smu}}{d-x} - \frac{\varepsilon_{smy}}{d-x} \right)$$

Curvature at onset of yielding
Curvature at rupture of the reinforcement

Limitation of the plastic rotation by the concrete (compressive failure):

$$\Theta_{puc} = L_{pl} \left(\frac{\varepsilon_{c2d}}{x} - \frac{\varepsilon_{smy}}{d-x} \right)$$

Curvature at onset of yielding
Curvature at concrete crushing

L_{pl} Plastic hinge length, depending on load configuration and geometry: region in which the chord reinforcement yields (\rightarrow determine the chord force distribution from the stress field).

ε_{smu} Mean steel elongation when reaching	$\varepsilon_{sr} = \varepsilon_{ud}$	$\sigma_{sr} = f_t$	}	$\varepsilon_{sr} \leftrightarrow \varepsilon_{sm}$ tension chord model (Stahlbeton I)
ε_{smy} Mean steel elongation when reaching	$\varepsilon_{sr} = \frac{f_s}{E_s}$	$\sigma_{sr} = f_s$		

Rotation per crack: $\Theta_i \approx \frac{\varepsilon_{sm} s_{rm}}{d-x}$

Plastic hinge rotation = sum of the plastic rotations of all cracks from the onset of yielding

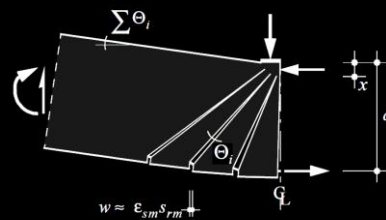

The rotational capacity can be estimated on the basis of a cross-sectional analysis. This is done by making an assumption about the length of the plastic hinge and by determining the plastic curvatures for the governing type of failure (concrete crushing or reinforcement rupture).

The rotational capacity (plastic rotation in [rad]) then results from the multiplication of the plastic curvatures [1/m] by the length of the plastic joint [m].

The plastic curvature corresponds to the curvature at failure (when the concrete reaches compression failure or the failure strain of the reinforcement is reached), minus the curvature at the onset of yielding of the reinforcement. Therefore, it does not contain any elastic deformation.

The governing type of failure is the one that occurs first (with smaller rotation). For the failure type «rupture of reinforcement», the elongation at failure ε_{su} of the bare reinforcement must not be used, since the deformation capacity is greatly reduced by the influence of the concrete between the cracks ("tension stiffening", i.e. the stiffening effect of the concrete between cracks).

Beams – Deformation capacity

Rotation demand ↔ Rotation capacity (simplified) - Example of a two-span beam

- C30/37:
 $f_{cd} = 20 \text{ MPa}$, $f_{ctm} = 2.9 \text{ MPa}$
- $d^- \approx 1.1 \text{ m}$, $A_s' f_{sd} = 1848 \text{ kN}$
 $\rightarrow x = \frac{1848}{0.85 \cdot 0.6 \cdot 20} = 181 \text{ mm}$
 $\frac{x}{d} = 0.16 \rightarrow$ Verification not required (see notes *)
 $d^- - x = 919 \text{ mm}$

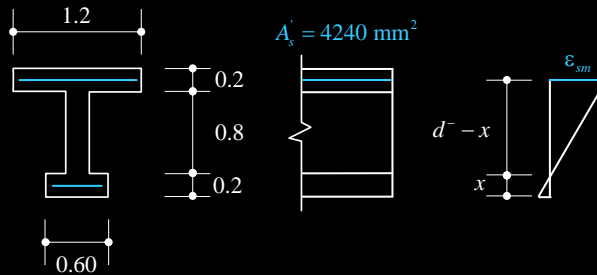

Rotation at failure:

$$\left. \begin{aligned} \Theta_{pucl} &= L_{pl} \cdot \left(\frac{\epsilon_{cu}}{x} - \frac{\epsilon_{smu}}{d^- - x} \right) \\ \Theta_{pus} &= L_{pl} \cdot \left(\frac{\epsilon_{smu}}{d^- - x} - \frac{\epsilon_{smu}}{d^- - x} \right) \end{aligned} \right\} \text{with } \frac{\epsilon_{smu}}{d^- - x} = \text{Curvature at onset of yielding} = \frac{f_s / E_s - \Delta \epsilon_0}{d^- - x} = 2.3 \text{ mrad/m}, L_{pl} = \text{length plastic hinge} \approx 2d^-$$

This and the following slides show an approximation to the rotational capacity for the example on slide 33 (see calculation of the deformation demand on slides 33 - 35).

It is assumed that an average elongation at failure of $\epsilon_{smu} \approx 0.5 \cdot \epsilon_{ud}$ may be assumed for the reinforcement and that the length of the plastic hinge corresponds to twice the static depth, $L_{pl} \approx 2 \cdot d$.

These assumptions will be verified with a more refined calculation. We will see that they are relatively good for B500C, but unconservative for B500B. For reinforcing steel of ductility class B, smaller values for ϵ_{smu} and L_{pl} would have to be selected in order to be on the safe side (e.g. $L_{pl} \approx 1.5 \cdot d$ and $\epsilon_{smu} \approx 0.3 \cdot \epsilon_{ud}$).

* Additional remark:

In this example the ratio of x/d is 0.16. According to the code SIA 262, no deformation capacity issues are expected for this ratio. However, the code only considers the deformation capacity of the concrete: limited capacity of the reinforcement is not taken into account. Within this example, we want to show that the deformation capacity of the reinforcement might also be governing in cases with low x/d ratios (as already stated on slide 36). The following example investigates both the failure of the reinforcement and of concrete. This verification can be applied for any ratio of x/d .

Beams – Deformation capacity

Rotation demand ↔ Rotation capacity (simplified) - Example of a two-span beam

Rotation at failure:

Concrete crushing

$$\Theta_{puc} = L_{pl} \cdot \left(\frac{\varepsilon_{cu}}{x} - \frac{\varepsilon_{smv}}{d' - x} \right) \approx 2 \cdot 1.10 \cdot \left(\frac{0.003}{0.181} - 0.0023 \right) = 14.3 \frac{\text{mrad}}{\text{m}} \cdot 2.2 \text{ m} = 31.4 \text{ mrad}$$

→ $\Theta_{puc} > \Theta_{B, dem}$ → OK

Steel rupture

rough assumption: $\varepsilon_{smu} \approx 0.5 \varepsilon_{ud} = \begin{cases} 22.5\% \text{ (B500B)} \\ 32.5\% \text{ (B500C)} \end{cases}$ (estimated reduction of elongation at failure due to tension stiffening - see next slides)

$$\Theta_{pus} = L_{pl} \cdot \left(\frac{\varepsilon_{smu}}{d' - x} - \frac{\varepsilon_{smv}}{d' - x} \right) = \begin{cases} 2 \cdot 1.10 \cdot \left(\frac{0.0225}{0.919} - 0.0023 \right) = 22.2 \frac{\text{mrad}}{\text{m}} \cdot 2.2 \text{ m} = 48.8 \text{ mrad (B500B)} \\ 2 \cdot 1.10 \cdot \left(\frac{0.0325}{0.919} - 0.0023 \right) = 33.1 \frac{\text{mrad}}{\text{m}} \cdot 2.2 \text{ m} = 72.7 \text{ mrad (B500C)} \end{cases}$$

→ $\Theta_{pus} > \Theta_{B, dem}$ → OK

The rotation capacity would be verified.

But: Are the assumptions of L_{pl} , ε_{smu} all right?

With the assumptions made ($\varepsilon_{smu} \approx 0.5 \cdot \varepsilon_{ud}$, $L_{pl} \approx 2 \cdot d$) sufficient deformation capacity can be verified (for B500B and B500C), i.e. the rotational capacity is greater than the rotational demand.

However, are the assumptions made justified? This will be checked on the following slides by means of a more detailed investigation:

- Mean elongation of the tension chord at rupture of the reinforcement: derived based on the the tension chord model
- Length of the plastic hinge (and strain distribution over the length of the plastic hinge): investigated with stress fields

Beams – Deformation capacity

Rotation capacity Θ_{pu} (detailed investigation) - Basics

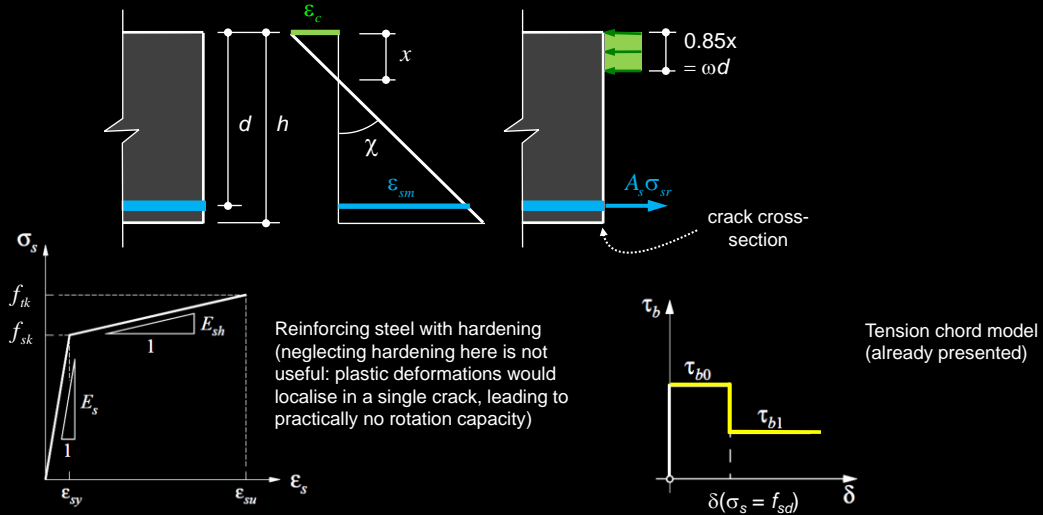

The stiffness and deformation capacity of a tension chord can be investigated with the tension chord model.

The tension chord model is a simplified model based on a clear mechanical basis including the stiffening effect of the concrete between the cracks. It is based on a stepped, rigid-perfectly plastic bond stress-slip relationship, with which the complex bond behaviour can be analysed in a simplified way. The complex force transmission between concrete and reinforcement is accounted for by nominal shear stresses, which are assumed to be evenly distributed along the nominal circumference of the bar.

Beams – Deformation capacity

Rotation capacity (detailed investigation) - Example of a two-span beam

- C30/37:
 $f_{cd} = 20 \text{ MPa}$, $f_{ctm} = 2.9 \text{ MPa}$
- $d^- \approx 1.1 \text{ m}$, $A_s' f_{sd} = 1848 \text{ kN}$
 $\rightarrow x = \frac{1848}{0.85 \cdot 0.6 \cdot 20} = 181 \text{ mm}$
 $d^- - x = 919 \text{ mm}$

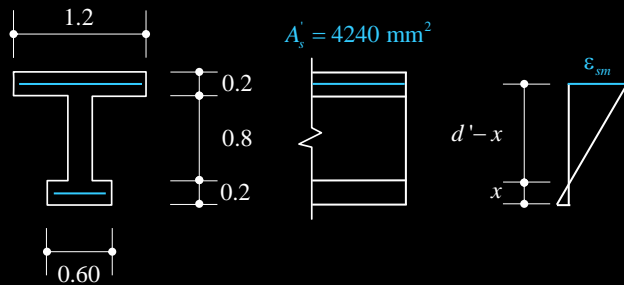

Equivalent reinforcement ratio (considering x at failure, see notes *):

$$\rho_{eff} = \frac{1}{\frac{M_r (d^- - x) E_s}{f_{ct} E I^II} + 1 - n} = 2.2\%$$

$$s_{m0} \approx \frac{\varnothing}{4} \cdot \left(\frac{1}{\rho_t} - 1 \right) = 292 \text{ mm} \quad \left(\lambda = \frac{1}{2} \dots 1 \right)$$

$$\rightarrow s_m \approx 250 \text{ mm} \text{ (spacing of stirrups)}$$

On this and the following slides the deformation capacity is investigated by using the tension chord model. In a first step, the effective tension chord reinforcement of the beam under bending is determined.

* Additional remark:

- The indicated equivalent reinforcement ratio was determined according to the procedure described on slide 23, using the height of the compression zone x corresponding to the ultimate limit state (ULS). This is a simplification. In order to determine the equivalent reinforcement ratio, the height of the compression zone in the cracked-elastic phase is to be used (SLS). However, due to the fact that the compression zone of the cracked-elastic phase reaches into the web of the beam, the calculation is rather complicate. The following values are used for the example (considering x at ULS): $f_{ct} = 2.9 \text{ MPa}$, $M_r = 612 \text{ kNm}$, $E I^II = 780 \text{ MNm}^2$, $(d-x) = 919 \text{ mm}$ (flange $b = 0.60 \text{ m}$, web $b = 0.20 \text{ m}$). The correct values considering x at SLS would be: $f_{ct} = 2.9 \text{ MPa}$, $M_r = 578 \text{ kNm}$, $E I^II = 729 \text{ MNm}^2$, $x = 273.6 \text{ mm}$, $(d-x) = 826.4 \text{ mm}$ (flange $b = 0.60 \text{ m}$, web $b = 0.20 \text{ m}$). These values would lead to a slightly different equivalent reinforcement ratio of 2.4%. Considering an equivalent reinforcement ratio of 2.4% instead of 2.2% would not change the overall conclusions of the example.

Beams – Deformation capacity

Rotation capacity (detailed investigation) - Example of a two-span beam

Tension chord model

- $\varnothing = 26 \text{ mm}$
- $s_{rm} = 250 \text{ mm}$ (spacing of stirrups)
- $E_s = 205 \text{ GPa}$
- $f_{cm} = 2.9 \text{ MPa}$
- $\tau_{b0} = 2f_{cm} = 5.8 \text{ MPa}$
- $\tau_{b1} = 1f_{cm} = 2.9 \text{ MPa}$

1 $\sigma_{sr} < f_s$ "elastic"

$$\rightarrow \varepsilon_{sm} = \frac{\sigma_{sr}}{E_s} - \frac{\tau_{b0} s_r}{E_s \varnothing} = \frac{\sigma_{sr}}{E_s} - 0.27\text{‰}$$

nackter Stahl $\Delta\sigma_s = \Delta\sigma_{st}$

2 $\sigma_{sr} > f_s, \sigma_{smin} < f_s \rightarrow \dots$; Transition to regime **3** at
"partially yielded"

$$\sigma_{smin} = \sigma_{sr} - \frac{2\tau_{b1} s_r}{\varnothing} = \sigma_{sr} - 56 \text{ MPa} \stackrel{!}{=} f_s$$

$\rightarrow \sigma_{sr} = f_s + 56 \text{ MPa} \rightarrow \text{B500B stays at regime 2}$

3 $\sigma_{smin} > f_s$
"fully yielded"

$$\rightarrow \varepsilon_{sm} = \frac{f_s}{E_s} + \frac{\sigma_{sr} - f_s}{E_{st}} - \frac{\tau_{b1} s_r}{E_{st} \varnothing}$$

nackter Stahl $\Delta\sigma_s = \Delta\sigma_{st}$

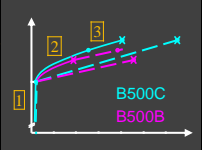

- B500C:** $\varepsilon_{sm}(\sigma_{sr} = f_s) = 2.43 - 0.27 = 2.16\text{‰}$
 $\varepsilon_{sm}(\sigma_{smin} = f_s) = 25.9\text{‰}$ (**3**) with $\sigma_{sr} = 556 \text{ MPa}$
 $\varepsilon_{sm}(\sigma_{sr} = f_t) = 65 - 23 = 42\text{‰} = \varepsilon_{smu}$
- B500B:** $\varepsilon_{sm}(\sigma_{sr} = f_s) = 2.16\text{‰}$
 $\varepsilon_{smu} = 17.7\text{‰}$ (Regime **2** with $\sigma_{sr} = f_t$, does not reach regime **3**)

23‰ (B500C)
30‰ (B500B)

$$\sigma_{sr} = f_{sd} + E_{st} \left(\varepsilon_m - \frac{f_t}{E_s} \right) + \frac{\tau_{b1} s_r}{\varnothing}$$

29 MPa

With the effective reinforcement ratio, the characteristic curves of the tension chord (force or steel stress - average strains) can be determined.

These are shown on the following slides for B500B and B500C. It should be noted that reinforcement B500B does not reach regime 3 (reinforcement yields over the entire crack element), but fails in regime 2 (reinforcement yields only near the cracks). This greatly impairs the ductility. The primary reason for this is the insufficient hardening of the B500B (and less the lower strain at failure).

For the (graphical) construction of the characteristic curves, the fact that regime 3 is reached when the minimum steel stress σ_{smin} (in the middle between two cracks) exceeds the yield point, can be used. The minimum steel stress in Regime 3 differs from the maximum steel stress σ_{sr} (at the crack) by a constant amount (in the example 56 MPa).

Beams – Deformation capacity

Rotation capacity (detailed investigation) - Example of a two-span beam

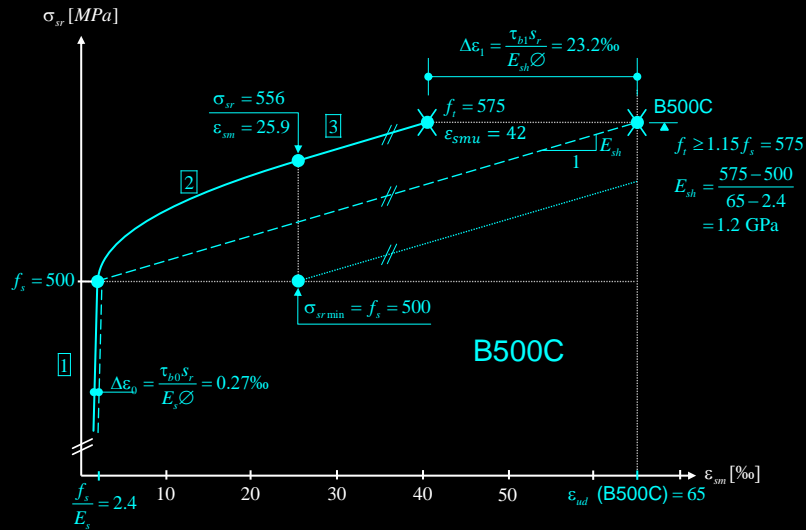

Characteristic curve of the tension chord for B500C:

- Reduction of elongation at failure from $\epsilon_{ud} = 6.5\%$ (bare reinforcement, dashed line) to $\epsilon_{smu} = 4.2\%$ (tension chord, solid line)
- Failure in regime 3 (fully yielded)

Beams – Deformation capacity

Rotation capacity (detailed investigation) - Example of a two-span beam

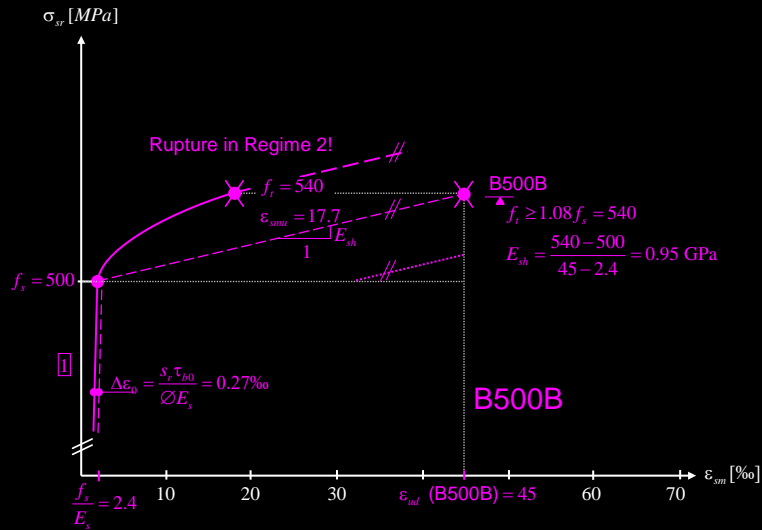

Characteristic curve of the tension chord for B500B:

- Reduction of elongation at failure from $\epsilon_{ud} = 4.5$ % (bare reinforcement, dashed line) to $\epsilon_{smi} = 1.8$ % (tension chord, solid line)
- Failure in regime 2 (partially yielded)

Beams – Deformation capacity

Rotation capacity (detailed investigation) - Example of a two-span beam

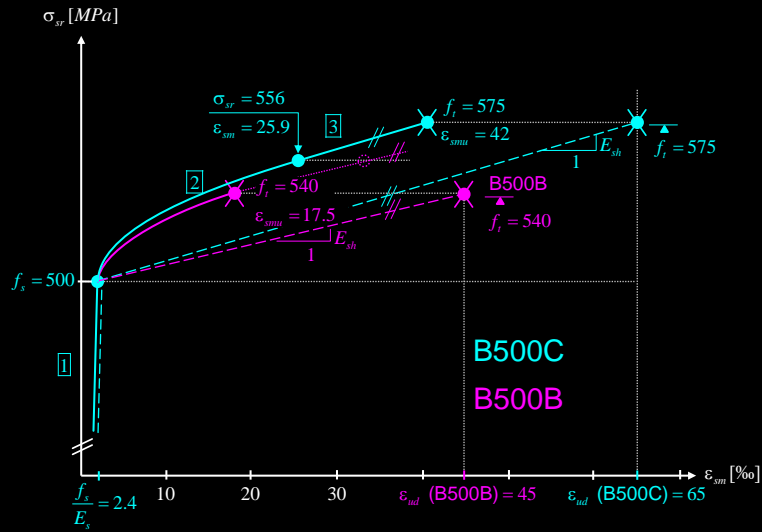

Comparison of the characteristic curves of the tension chord for B500B and B500C. The difference in the ductility of the bare reinforcement is clearly accentuated by the bond.

Beams – Deformation capacity

Rotation capacity (detailed investigation) - Example of a two-span beam

Plastic hinge length → Distribution of the top chord force F_{sup} determined from a stress field

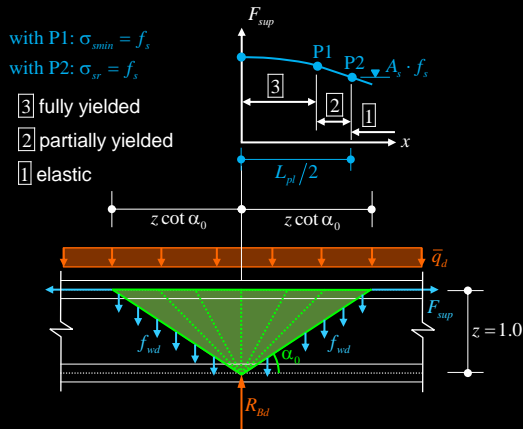

$$\frac{dF_{sup}}{dx} = -(\bar{q}_d + f_{wd}) \cot \alpha_0(x)$$

$$\cot \alpha_0(x) = x/z$$

$$F_{sup}(x) = A_s f_s - \frac{x^2 (\bar{q}_d + f_{wd})}{2z}$$

$$\sigma_{sr} = f_s : F_{sup} = A_s f_s = A_s f_s - \frac{x^2 (\bar{q}_d + f_{wd})}{2z}$$

$$\rightarrow x_{P2} = \sqrt{\frac{2A_s (f_s - f_s) z}{\bar{q}_d + f_{wd}}}$$

$$\sigma_{smin} = f_s : \sigma_{sr} = f_s + \frac{2\tau_{bt} s_{rm}}{\emptyset}$$

$$\rightarrow x_{P1} = \sqrt{\frac{2A_s \left(f_s - f_s - \frac{2\tau_{bt} s_{rm}}{\emptyset} \right) z}{\bar{q}_d + f_{wd}}}$$

In addition to the magnitude of the deformations of the tension chord at the rupture of the reinforcement, the length of the plastic hinge must also be determined, as well as the strain distribution in this area. These values can be examined with a stress field, for which a point-centred fan is assumed for simplicity. In the investigated failure state (rupture of the tension chord reinforcement) the stress in the top chord reinforcement over the support is $\sigma_{sr} = f_t$ (tensile strength of the reinforcement). Starting from this point, the parabolic distribution of the tension chord force can be determined.

By equating the force in the tension chord with the regime limits from the tension chord model, the region in which plastic deformations occur ("plastic hinge length") can be determined (fully yielded zone with $\sigma_{smin} = f_s$, partially yielded with $\sigma_{sr} = f_s$). The first region (from the support up to P1) is fully yielded, the second (P1 to P2) is partially yielded.

Additional remark:

- It is assumed that the reinforcement is not curtailed, but a curtailment could also be taken into account (the length of the plastic hinge would be larger in this case).

Beams – Deformation capacity

Rotation capacity (detailed investigation) - Example of a two-span beam

Plastic hinge length \rightarrow Distribution of the top chord force F_{sup} determined from a stress field

R_{Bd} increases during the redistribution, x_p thus decreases (large gradient of M is unfavourable for the rotational capacity, since a stronger localization of deformations occurs):

R_{Bd} (and thus x_p) also depends on the choice of the compression field inclination α_0 :

$$R_{Bd} = 2z \cot(\alpha_0)(\bar{q}_d + f_{wd}) \rightarrow (\bar{q}_d + f_{wd}) = \frac{R_{Bd}}{2z \cot(\alpha_0)}$$

large $\alpha_0 \rightarrow x_{p1}, x_{p2}$ small, small $\alpha_0 \rightarrow x_{p1}, x_{p2}$ large

$$R_{Bd} = 2 \cdot \frac{5}{8} \cdot L \cdot \bar{q}_{dy} + 2 \cdot \frac{1}{2} \cdot L \cdot (\bar{q}_d - \bar{q}_{dy})$$

$$= \frac{1156 \text{ kN}}{\text{Reaction for } \bar{q}_d} + \frac{675 \text{ kN}}{\text{additional for } \bar{q}_d > \bar{q}_{dy}} = 1831 \text{ kN}$$

(für $EI^- = EI^+$)

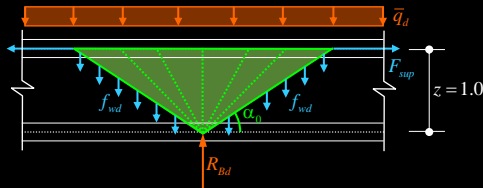

- \rightarrow Several assumptions are necessary to determine the deformation capacity
- \rightarrow Rough estimation, not exact calculation!

Additional remarks:

- With high amounts of shear reinforcement it is possible that the yielded area extends into the adjacent parallel compression field. The inclination of the parallel field (and thus the length of the fan area) results from the assumption that the vertical reinforcement can absorb the support reaction over a length $z \cdot \cot(\alpha)$ (on both sides of the support). In this case, the chord force distribution would have to be adjusted (the curve is linear over the parallel field).
- The distribution of the chord force depends on the magnitude of the reaction (if the stirrups are not fully used), corresponding to the gradient of the moment distribution. Since the reaction increases in the course of the redistribution of the internal forces, the length of the yielded area is not constant. Such effects also influence the rotation demand. Strictly speaking, the rotation capacity and the rotation demand should be investigated in a coupled way.
- Strictly speaking, discrete crack spacing should be taken into account when determining the areas in which plastic strains occur. For the sake of simplicity this is neglected here.

Beams – Deformation capacity

Rotation capacity (detailed investigation) - Example of a two-span beam

Plastic hinge length → Distribution of the top chord force F_{sup} determined from a stress field

→ Assumption: $R_{bd} \approx 1500 \text{ kN}$, $\cot(\alpha_0) = 1.5$ ($\alpha_0 = 33.5^\circ$), $(\bar{q}_d + f_{wd}) = \frac{1500}{2 \cot(\alpha_0)} = \frac{1500}{3} = 500 \text{ kNm}^{-1}$

B500B: $x_{P2} = \sqrt{\frac{2 \cdot 4240(540 - 500) \cdot 1000}{500}} = 823 \text{ mm}$ (" $L_{pl}/2$ ")

B500C: $x_{P2} = \sqrt{\frac{2 \cdot 4240(575 - 500) \cdot 1000}{500}} = 1127 \text{ mm}$ (" $L_{pl}/2$ ")

$x_{P1} = \sqrt{\frac{2 \cdot 4240(575 - 556) \cdot 1000}{500}} = 571 \text{ mm}$

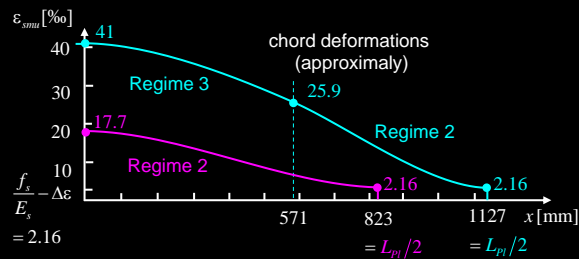

B500B: $\bar{\epsilon}_{smm} = \frac{2}{L_{pl}} \cdot \int_0^{x_{P2}} \epsilon_{smm}(x) \cdot dx$
 $= 10.5\text{‰}$ (averaged over $L_{pl} = 1.65 \text{ m}$)

B500C: $\bar{\epsilon}_{smm} \approx \frac{2}{L_{pl}} \cdot \left(\int_0^{x_{P1}} \epsilon_{smm}(x) \cdot dx + \int_{x_{P1}}^{x_{P2}} \epsilon_{smm}(x) \cdot dx \right)$
 $= 24.1\text{‰}$ (averaged over $L_{pl} = 2.25 \text{ m}$)

The plastic deformations of the tension chord are obtained by the integration of the plastic strains over the area in which such strains occur ("plastic hinge length").

The plastic strains are not evenly distributed, but vary relatively strongly.

With the assumptions made, a plastic hinge length (twice the distance from the support to P2, since the problem is symmetric) of 1.65 m for B500B and 2.25 m for B500C results, with plastic strains averaged over these lengths of 1.05% (B500B) and 2.4% (B500C), respectively.

Beams – Deformation capacity

Rotation demand and rotation capacity (detailed investigation) - Example two-span beam

Plastic rotation at failure

Concrete crushing

$$\Theta_{puc} = L_{pl} \cdot \left(\frac{\varepsilon_{cu}}{x} - \frac{\varepsilon_{smy}}{d-x} \right) \approx 2 \cdot 1.10 \cdot \left(\frac{0.003}{0.181} - 0.0023 \right) = 14.3 \frac{\text{mrad}}{\text{m}} \cdot 2.2 \text{ m} = 31.4 \text{ mrad}$$

$\rightarrow \Theta_{puc} > \Theta_{B,req} \rightarrow \text{OK}$

Steel rupture

Rough assumption: $\varepsilon_{smu} \approx 0.5 \varepsilon_{ud} = \begin{cases} 22.5\text{‰} \text{ with } L_{pl} = 2.2 \text{ m (B500B)} \\ 32.5\text{‰} \text{ with } L_{pl} = 2.2 \text{ m (B500C)} \end{cases}$

More detailed investigation: $\bar{\varepsilon}_{smu} = \begin{cases} 10.5\text{‰} \text{ with } L_{pl} = 1.65 \text{ m (B500B)} \\ 24.1\text{‰} \text{ with } L_{pl} = 2.25 \text{ m (B500C)} \end{cases} \left\{ \begin{array}{l} \bar{\varepsilon}_{smu} \approx 0.23 \cdot \varepsilon_{ud}, L_{pl} \approx 1.5 \cdot d \\ \bar{\varepsilon}_{smu} \approx 0.37 \cdot \varepsilon_{ud}, L_{pl} \approx 2.0 \cdot d \end{array} \right.$

$$\Theta_{pus} = L_{pl} \cdot \left(\frac{\bar{\varepsilon}_{smu}}{d-x} - \frac{\varepsilon_{smy}}{d-x} \right) = \begin{cases} 1.65 \cdot \left(\frac{0.0105}{0.919} - 0.0023 \right) = 15.1 \text{ mrad (B500B)} < \Theta_{B,req} = 18.5 \text{ mrad } (\alpha_r = 1) \\ \hspace{15em} \text{not fulfilled!} \\ 2.25 \cdot \left(\frac{0.0241}{0.919} - 0.0023 \right) = 53.8 \text{ mrad (B500C)} \gg \Theta_{B,req} = 18.5 \text{ mrad } (\alpha_r = 1) \\ \hspace{15em} \text{ok (no problem)} \end{cases}$$

The comparison with the rough estimation shows that the plastic hinge length for a reinforcing steel of ductility class C corresponds to the assumptions made. However, the simplified approach overestimates the mean elongations at failure of the reinforcement. In the case of reinforcing steel of ductility class B, both values are significantly lower according to the more precise investigation. The rotation capacity, which would have been judged as satisfactory with the rough estimation, is not ok with the detailed investigation.

The assumptions made for the rough approximation ($\varepsilon_{smu} \approx 0.5 \cdot \varepsilon_{ud}$ and $L_{pl} \approx 2 \cdot d$) are therefore unsafe for B500B and B500C. Smaller values (e.g. $L_{pl} \approx 1.5 \cdot d$ and $\varepsilon_{smu} \approx 0.23 \cdot \varepsilon_{ud}$ for reinforcing steel B500B) would have to be applied in order to obtain accurate results.

The complexity of the problem is reflected in the remarks above and on the various slides. The examples also show that the calculated deformations are subject to considerably greater uncertainties than, for example, the load-bearing capacity. This does not change if even more complex calculation methods are used. For this reason, the choice of appropriate materials and a careful design are of particular importance when verifying the deformation capacity.

Beams – Deformation capacity

Additional considerations: ratio of mean strain to maximum strain in the cracks considering bond

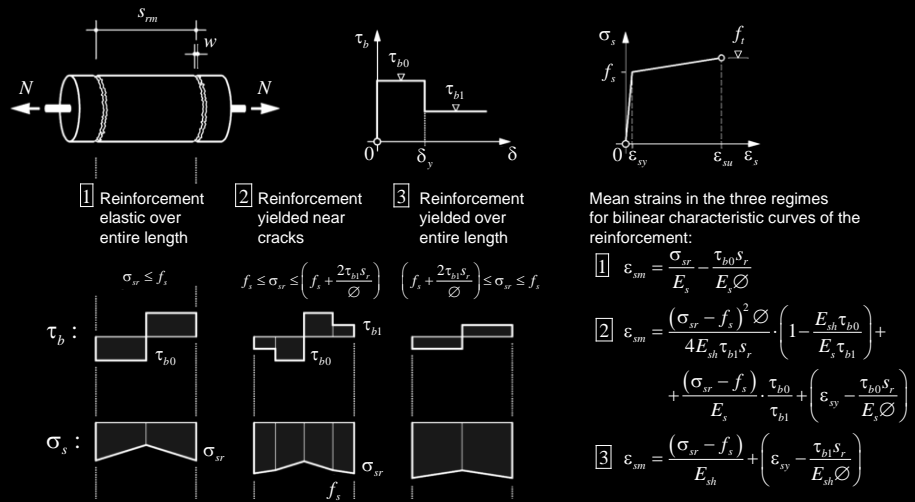

[Alvarez 1999]

So far, a strongly simplified, bilinear characteristic curve of the bare reinforcement steel has been assumed. Analogous investigations can be performed for general constitutive relationships of the bare reinforcement.

On this and the following slides, computational investigations from the dissertation of M. Alvarez (1998) are presented. In addition to the bilinear material law presented before, he also investigated more realistic constitutive relationships of the bare reinforcement with yield plateau (hot rolled, quenched & self-tempered (tempcore / microalloyed) and without yield plateau (hot rolled & stretched / cold formed).

Beams – Deformation capacity

Additional considerations: influence of the reinforcement hardening properties

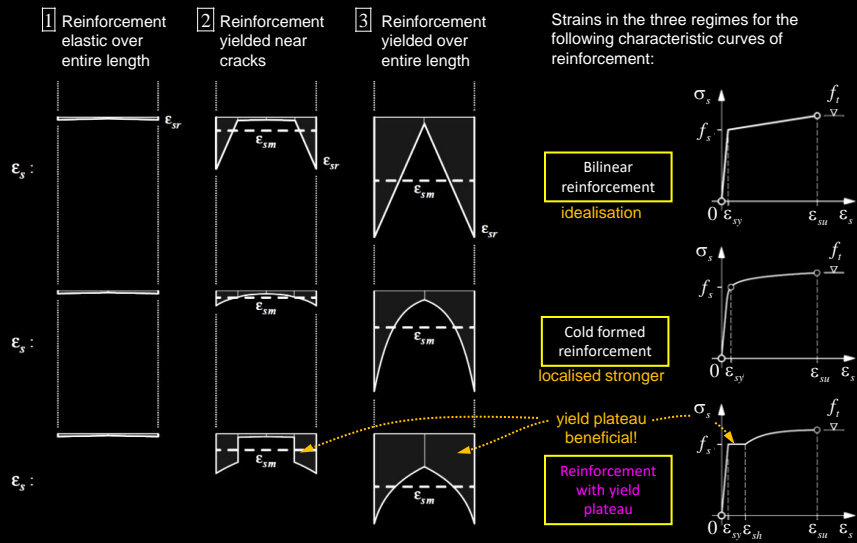

It can be seen that the yield plateau has a positive effect on ductility, since the areas of the crack element which show a stress only slightly above yield already have a significantly greater elongation (length of the yield plateau).

Beams – Deformation capacity

Additional considerations: influence of the reinforcement hardening properties

→ Reinforcement with a yield plateau is more favourable than cold-formed reinforcement, especially in case of failure in regime 2 (yield plateau contributes as an "additional" strain over the entire yielded area)

→ The bilinear idealization overestimates the deformation capacity for a reinforcement with high ductility

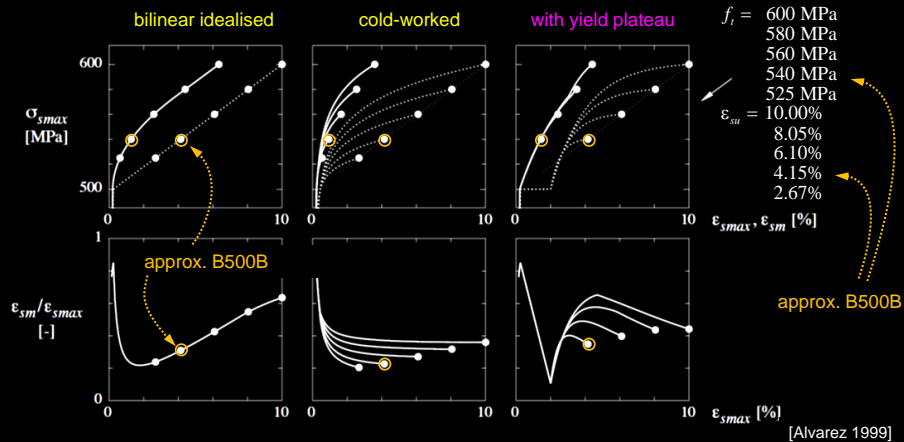

18.10.2023

ETH Zurich | Chair of Concrete Structures and Bridge Design | Advanced Structural Concrete

52

The shape of the bare reinforcement's constitutive relationship has a particularly strong influence on the behaviour immediately after exceeding the yield stress (regime 2).

In spite of its pronounced influence on the ductility of concrete structures, the hardening characteristics of the reinforcement cannot be specified by the designer (client). For example, when ordering B500B, the reinforcement provided may or may not have a yield plateau. Diameters up to 16 mm are usually transported on compact coils and do not have a yield plateau, diameters above 20 mm are transported as straight bars and often have a yield plateau – but exceptions are frequent.

Therefore, if ductility is essential, specifying reinforcement of ductility class C is highly recommended.

Tension experiments – Dr. M. Alvarez: Test setup

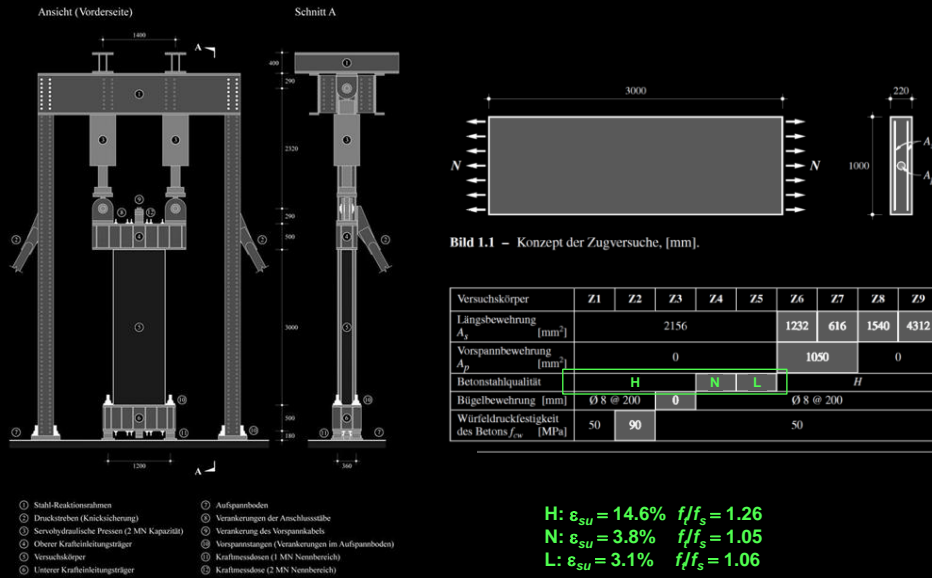

Repetition Stahlbeton I:

The figure shows the experimental setup and the parameters of the experiments of Alvarez and Marti (1996) with which the influence of the ductility of reinforced concrete in tension was investigated.

The motivation for these tests was potentially insufficient ductility of some of the reinforcing steel classes at that time (the assumption was confirmed in the tests). Today, the situation is similar for high-strength concretes with correspondingly high bond stresses; in such cases, the ductility of the B500B reinforcing steel, which is considered to be "ductile" per se, is frequently insufficient for large plastic redistributions.

Tension experiments – Dr. M. Alvarez: Crack patterns at failure

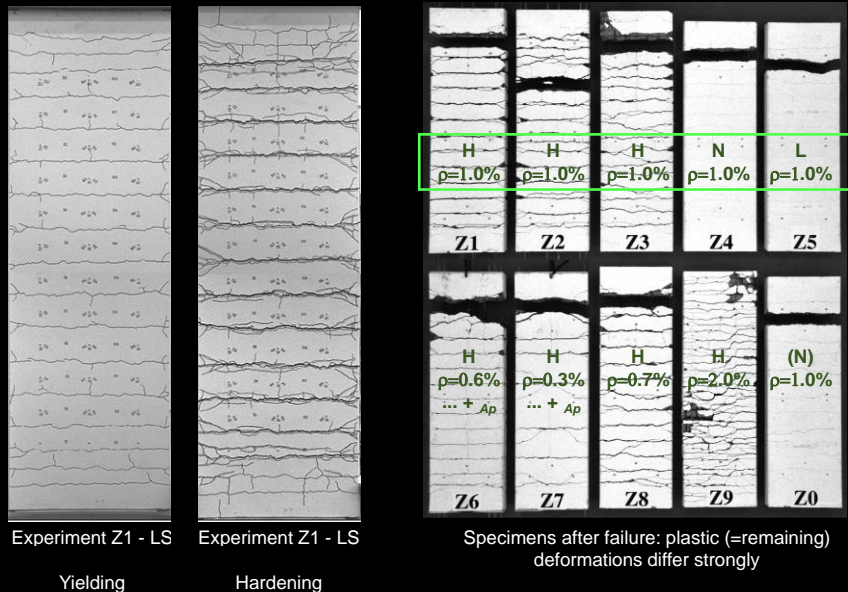

Repetition Stahlbeton I:

The slide shows the test specimens after failure, with the permanent (plastic) deformations. The specimens Z1-Z5 had the same geometrical reinforcement ratio (1%), specimen Z8 a slightly lower one (0.7%). Ductile reinforcement was used in specimens Z1-Z3 and Z8 ("H" = high ductility). Specimen Z4 was reinforced with low ductility reinforcement (at that time it was referred as normal ductility reinforcement = "N"). The reinforcement in specimen Z5, had very low ductility (at that time it was considered as low ductility = "L"). In the photos above one can see the huge differences in the plastic deformations between the specimens. On the following slides the corresponding test results are given, which confirm these qualitative observations.

Tension experiments – Dr. M. Alvarez: Test results

Load-deformation behaviour considering bond

→ Deformation capacity severely impaired for reinforcement with low ductility (failure deformation and hardening!)

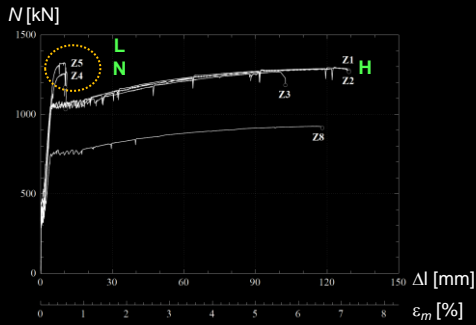

Ratio of average elongation to maximum elongation at the cracks considering bond

→ Good agreement with tension chord model (almost identical if the real bare steel curve is taken into account)

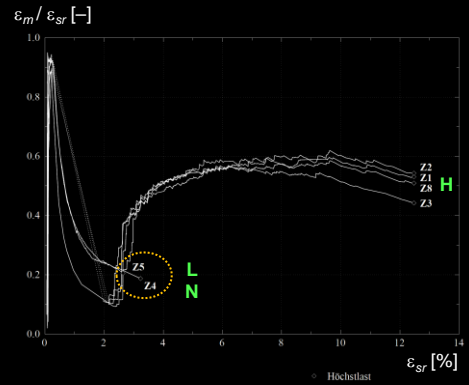

Repetition Stahlbeton I

Deformation capacity

Summary

- The concrete strength should be reduced in plastic analysis depending on the cracking state of the structure and on the material brittleness.
- The concrete contribution in tension between two cracks stiffens the response of bonded reinforcement with respect to bare (unbonded) reinforcement. This **tension-stiffening effect** affects the serviceability response of the structure but also **reduces the deformation capacity of the reinforcement**. Assuming simplified bond relationships (as e.g. in the Tension Chord Model) is sufficient for modelling tension-stiffening.
- **Deformation capacity and deformation demand are coupled**. The interaction can only be neglected for moderate redistributions of the internal forces.
- The **deformation demand** can be determined approximately with reasonable effort using simplified assumptions (constant bending stiffness of the elastic areas, rigid-ideal plastic $M-\theta$ relationships of the plastic hinges).
- Even with complex calculations, the **deformation capacity** can only be roughly estimated because it depends on several effects and assumptions that cannot be precisely quantified:
 - Bond behaviour, in particular, crack spacing
 - Mechanical properties of the reinforcement (hardening ratio and deformation of failure, with or without yield plateau)
 - Force flow in the area of plastic hinges, in particular, variation of the force in the tension chord
(→ the mean deformations averaged over the length of the plastic hinge are smaller than the mean deformation of a tension chord under constant tensile force!)
- In **practice**, it is therefore advisable to avoid the verification of the deformation capacity for new structures whenever possible (**complying with the condition $x/d < 0.35$**). Otherwise, it is often easier to ignore the redistribution of internal forces, i.e. to verify the structural safety for the elastic stresses including restraint stresses (even if the estimation of the restraints is also time-consuming and requires assumptions).
- If the deformation capacity needs to be verified (e.g. for existing structures), **engineering judgement must be applied**. The decisive parameters should be accounted for as accurately as possible (reinforcement: determine hardening characteristics, not just f_s).