

Effect of creep on two-span girder - time dependent force method

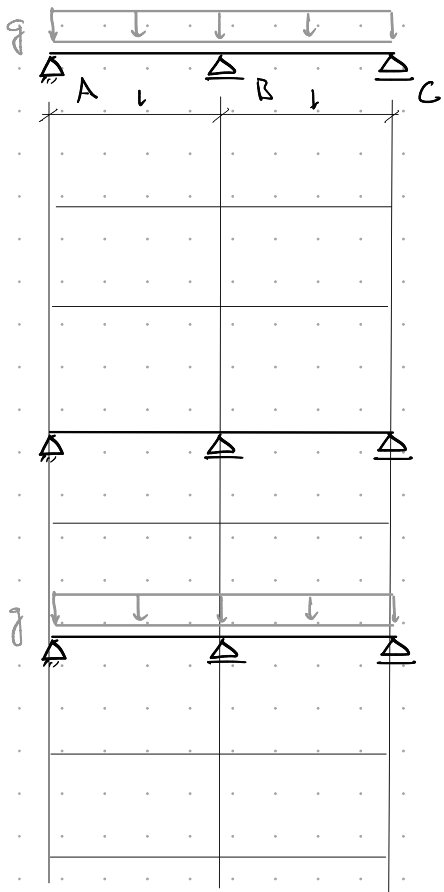

one casting system  
"Eingussystem"

here: for uncracked structure

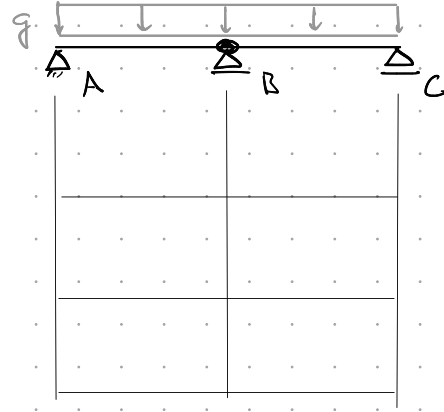

staged construction  
"Bauzustände"

for systems of same age

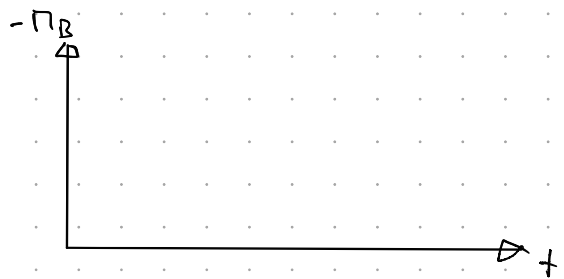
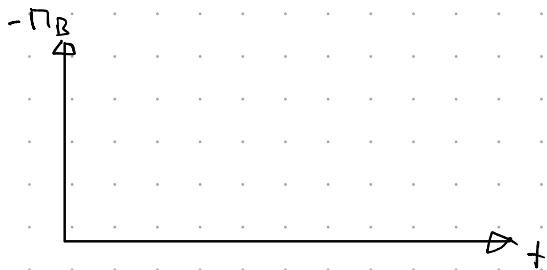

Support settlement  
Effect of creep for fast/slow settlement

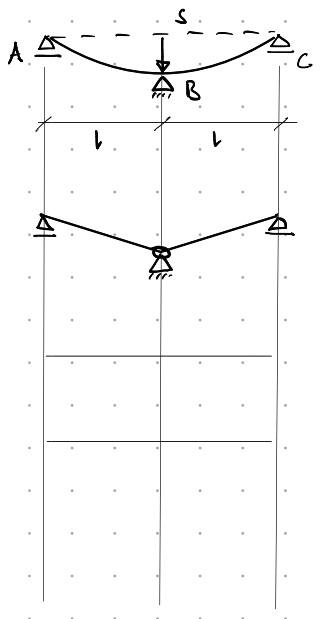

time-independent settlement ("fast" restraint)

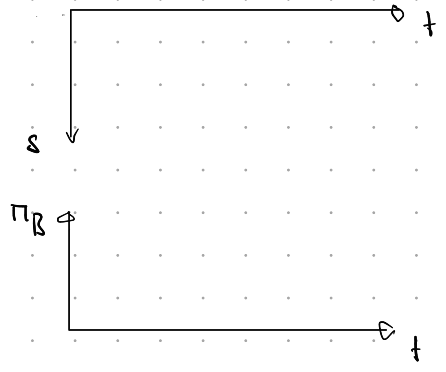

time-dependent settlement ("slow" restraint)

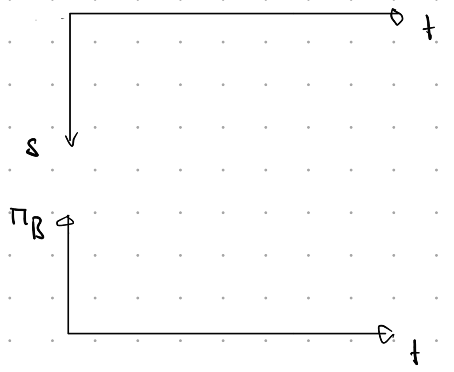

staged construction

for systems of different age

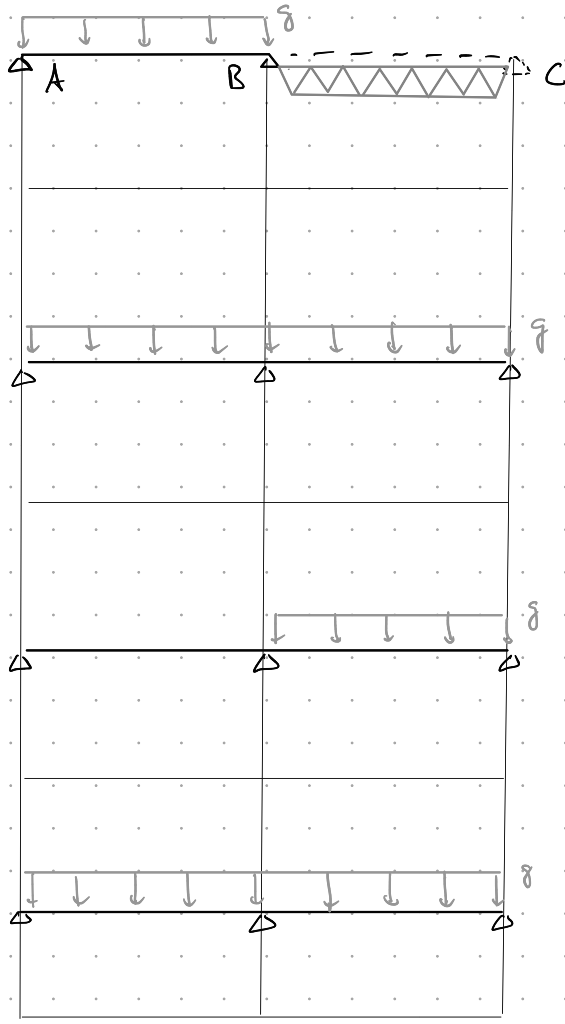

System 1  
 $t = t_1$

System f  
 $t \rightarrow \infty$

"System 2"

One casting system