

Dimensioning of a skew supported slab

Geometry

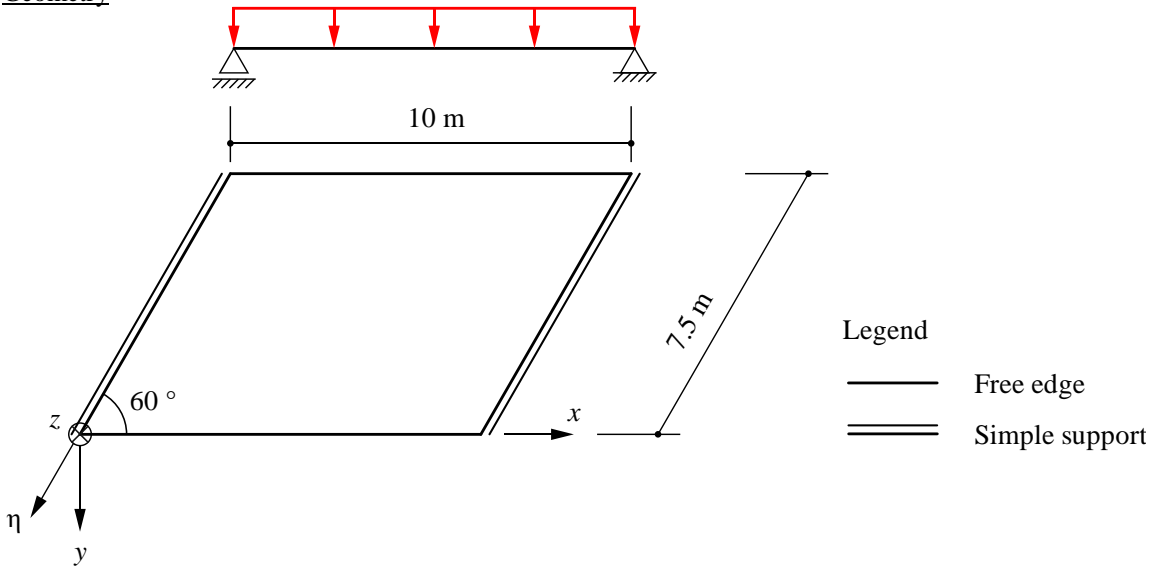

Material Properties

Concrete	C30/37	$f_{ck} = 30 \text{ MPa}; f_{cm} = 2.9 \text{ MPa}$ $f_{cd} = 20 \text{ MPa}; \tau_{cd} = 1.1 \text{ MPa}$ $E_{cm} = k_E \sqrt[3]{f_{cm}} \approx 33.6 \text{ GPa}$
Steel	B500B	$f_{sk} = 500 \text{ MPa}; f_{sd} = 435 \text{ MPa}$ $E_s = 205 \text{ GPa}$

SIA 262
Tab. 3
Tab. 8
3.1.2.3.3
Tab. 5/9
3.2.2.4

a) Choosing slab thickness

$$h_{sl} = 0.45 \text{ m} \hat{=} \frac{L}{22} \quad \text{ok}$$

Tab. 7/10

Loads

Dead weight: $g_{0,k} = h_{sl} \cdot \gamma_c = 0.45 \text{ m} \cdot 25 \frac{\text{kN}}{\text{m}^3} = 11.25 \text{ kPa}$

Non-structural dead weight: $g_{1,k} = 3.0 \text{ kPa}$

Live load: $q_k = 15.0 \text{ kPa}$

Ultimate limit state type 2 SIA 260:

$$q_d = 1.35 \cdot (g_{0,k} + g_{1,k}) + 1.5 \cdot q_k = 41.7 \text{ kPa} \cong 42 \text{ kPa}$$

acting on the entire surface of the slab

b) Minimum reinforcement for bending and shear forces

- Minimum bending reinforcement:

The cracking moment needs to be carried by the reinforcement → avoid a brittle failure when reaching f_{ctd} .

$$f_{ctd} = k_t \cdot f_{ctk,0.95} = 3.51 \text{ MPa}$$

$$k_t = \frac{1}{1 + 0.5 \cdot t}, \quad t = \frac{h_{sl}}{3}$$

$$f_{ctk,0.95} = 1.3 \cdot f_{cm}$$

4.4.1.3
4.4.1.4
3.1.2.2.5

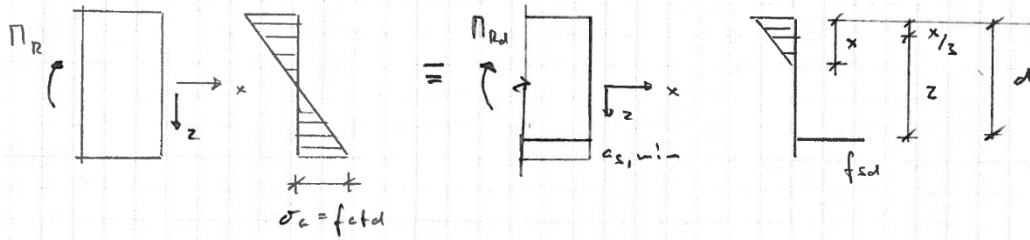

$$m_R = \frac{h^2 \cdot b}{6} \cdot f_{cd} = 118.5 \frac{\text{kNm}}{\text{m}'}$$

$$m_R \approx a_{s,erf} \cdot f_{sd} \cdot z \approx a_{s,erf} \cdot f_{sd} \cdot 0.8h$$

$$\rightarrow a_{s,erf} \approx \frac{m_R}{0.8h \cdot f_{sd}} = 757 \frac{\text{mm}^2}{\text{m}'}$$

Choice: $\varnothing 14 @ 200$, $a_s = 770 \frac{\text{mm}^2}{\text{m}'}$

$$d = h_{Sl} - c_{nom} - \varnothing_{Stirrup} - \frac{\varnothing_L}{2} = 376 \text{ mm} \quad (\text{Assumption: } \varnothing_{Stirrup} = 12 \text{ mm})$$

$$x = d \cdot (\sqrt{(\rho \cdot n)^2 + 2\rho \cdot n} - \rho \cdot n) = 0.146 \cdot d = 55 \text{ mm}$$

$$m_{Rd} = \left(d - \frac{x}{3}\right) \cdot a_s \cdot f_{sd} = 120 \frac{\text{kNm}}{\text{m}'} \geq m_R = 118.5 \frac{\text{kNm}}{\text{m}'} \quad \text{ok.}$$

Assumption:
 $z \approx 0.8h$

$$c_{nom} = 55 \text{ mm}$$

$$n = \frac{E_s}{E_c} = 6.1$$

$$\rho = \frac{a_s}{d \cdot h} = 0.2\%$$

- Minimum shear reinforcement

In slabs, a minimum shear reinforcement is not required by code (in contrast to beams).

If no shear reinforcement is placed, at least half of the bending reinforcement required for the maximum bending moment should be anchored at the supports.

SIA 262 5.5.3.4

If shear reinforcement is placed, its minimum content is the same as for beams.

ρ_w (SIA) is not advisable for new construction (robustness)

SIA 262 5.5.3.4

$\rightarrow \rho_{w,min} = 0.2\%$, Choice: Stirrups $\varnothing 10$, $s_x = s_y = 200 \text{ mm}$, e.g. Aschwanden DURA-60L

$$\rho_w = \frac{12^2 \cdot \pi}{4 \cdot (200 \text{ mm})^2} = 0.28\% \quad \text{ok}$$

$$v_{Rd,s} = A_s \cdot f_{sd} \cdot \frac{z \cdot \cot \alpha}{s_x} \cdot \frac{b}{s_y} = \rho_w \cdot f_{sd} \cdot z \cdot \cot \alpha \cdot b' = 438 \frac{\text{kN}}{\text{m}'}$$

Check of the concrete compression diagonal:

$$v_{Rd,c} = b \cdot z \cdot k_c \cdot f_{cd} \cdot \sin \alpha \cdot \cos \alpha$$

$$= 1980 \frac{\text{kN}}{\text{m}'} \gg v_{Rd,s}$$

$$v_{Rd} = \min(v_{Rd,s}, v_{Rd,c}) = 438 \frac{\text{kN}}{\text{m}'}$$

Assumption
 $z = 0.8h$
 $= 360 \text{ mm}$

$$\alpha = 45^\circ$$

$$k_c = 0.55$$

c) Dimensioning with the strip method

- Load bearing behaviour of the skew supported slab

obtuse corners

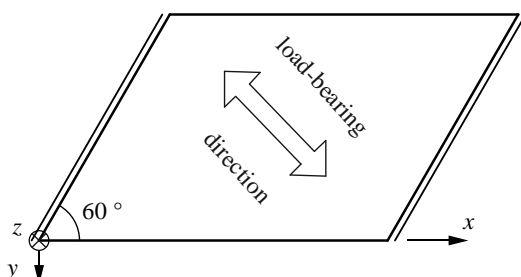

- The skew supported slab carries the load primarily in the direction of the shortest span.

- In the obtuse corners large shear forces occur

- Alternative possibilities for the application of the strip method

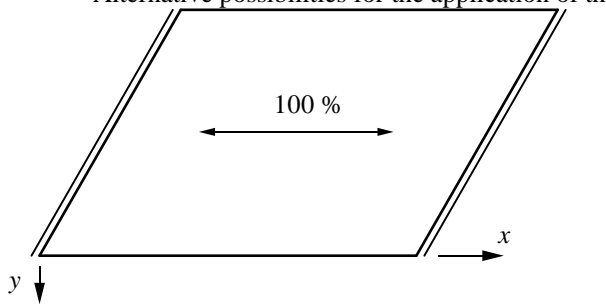

Alternative A:

Advantage:

- Simple hand calculation

Disadvantage

- Load bearing behaviour in the obtuse corners insufficiently considered

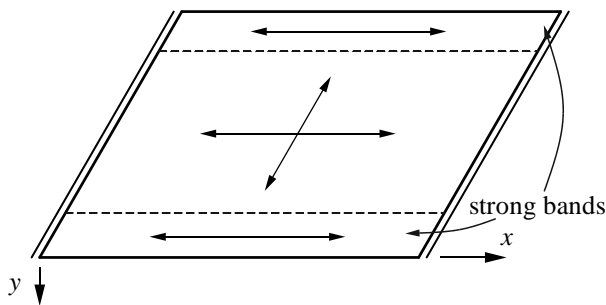

Alternative B:

Advantage:

- Simple hand calculation

Disadvantage

- Similar to Alternative A

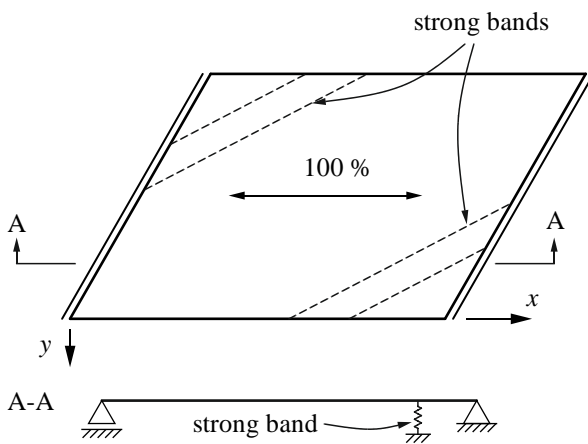

Alternative C:

Advantage:

- Negative bending moments in the obtuse corners considered

Disadvantage

- Too intricate for hand calculations

Choice: Alternative B

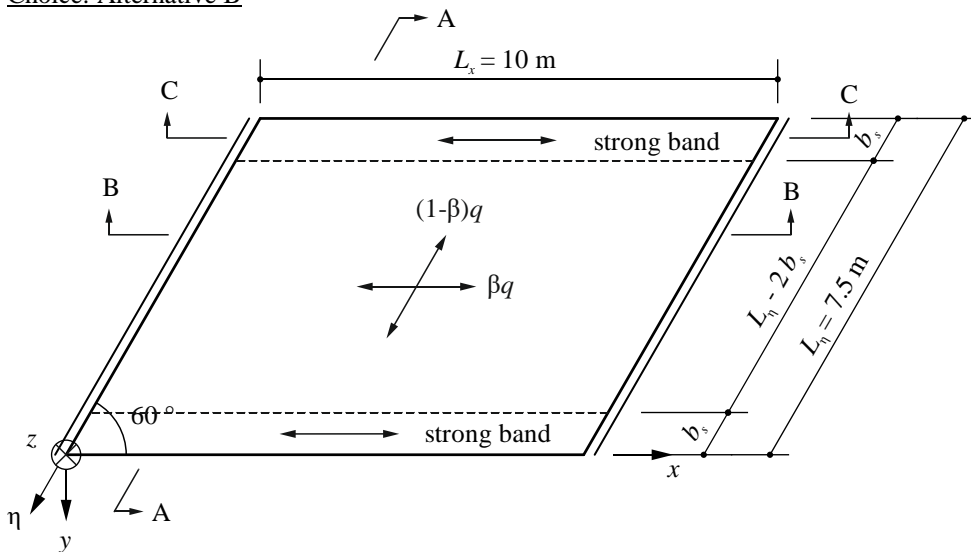

Free choice of $b_s = 0.85 \text{ m}$ and $\beta = 0.9$.

Exercise 3

Solution

hs/lg

- Section A-A

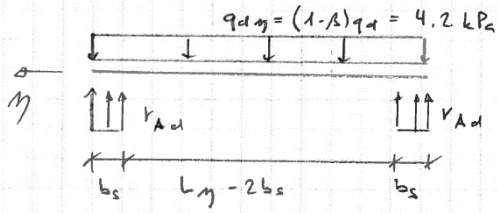

$$v_{Ad} = \frac{q_{d,\eta} \cdot \frac{L_\eta}{2}}{b_s} = 18.5 \frac{\text{kN}}{\text{m}^2}$$

$L_\eta = 7.5\text{m}$

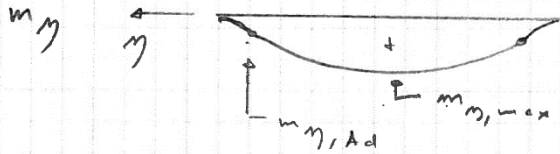

$$m_{\eta,max} = v_{Ad} \cdot b_s \left(\frac{L_\eta}{2} - \frac{b_s}{2} \right) - q_{d,\eta} \cdot \frac{1}{2} \left(\frac{L_\eta}{2} \right)^2$$

$$= 22.8 \frac{\text{kNm}}{\text{m}'}$$

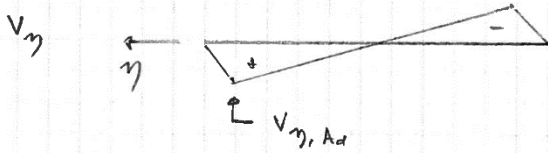

$$m_{\eta,Ad} = (v_{Ad} - q_{d,\eta}) \cdot \frac{b_s^2}{2} = 5.2 \frac{\text{kNm}}{\text{m}'}$$

$$v_{\eta,Ad} = (v_{Ad} - q_{d,\eta}) \cdot b_s = 12.2 \frac{\text{kN}}{\text{m}'}$$

- Section B-B

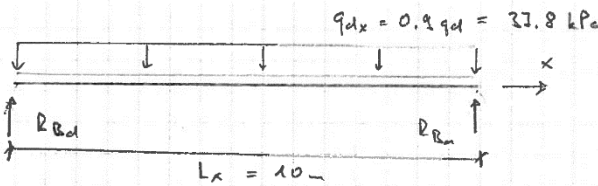

$$R_{Bd} = \frac{L_x}{2} \cdot q_{dx} = 189 \frac{\text{kN}}{\text{m}'}$$

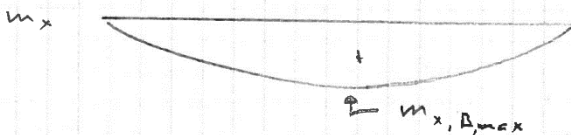

$$m_{x,B,max} = q_{dx} \cdot \frac{L_x^2}{8} = 472.5 \frac{\text{kNm}}{\text{m}'}$$

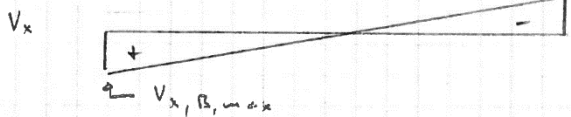

$$v_{x,B,max} = R_{Bd} = 189 \frac{\text{kN}}{\text{m}'}$$

- Section C-C

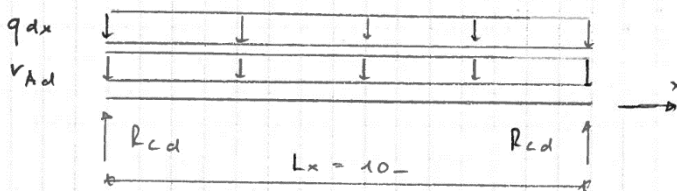

$$b_s \cdot (q_{dx} + v_{Ad}) = 47.9 \frac{\text{kN}}{\text{m}'}$$

$$R_{Cd} = 47.9 \cdot \frac{L_x}{2} = 239 \text{kN}$$

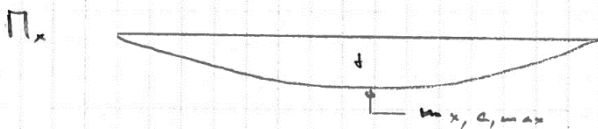

$$M_{x,c,max} = 42.2 \cdot \frac{L_x^2}{8} = 598 \text{kNm}$$

$$V_{x,c,max} = R_{Cd} = 239 \text{kN}$$

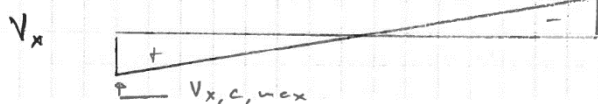

$$v_{x,c,max} = \frac{V_{x,c,max}}{b_s} = 281 \frac{\text{kN}}{\text{m}'}$$

- Check of the bending resistance

- o Centre of the slab: ($x = 6.878\text{ m}$, $y = 3.25\text{ m}$)

$$m_{x,B,max} = 472.5 \frac{\text{kNm}}{\text{m}'}, \quad m_{\eta,max} = 22.8 \frac{\text{kNm}}{\text{m}'}$$

Choice: $\varnothing 26 @ 150$, $a_{sx} = 3540 \frac{\text{mm}^2}{\text{m}'}$ x-direction

$$d_{1,4} = h_{sl} - c_{nom} - \frac{\varnothing}{2} = 382\text{ mm}$$

$$x = \frac{a_{sx} \cdot f_{sd}}{0.85 \cdot b' \cdot f_{cd}} = 91\text{ mm} \rightarrow \frac{x}{d_{1,4}} = 0.23 < 0.35 \text{ ok}$$

$$m_{x,u} = a_{sx} \cdot f_{sd} \cdot \left(d_{1,4} - \frac{0.85x}{2} \right) = 529 \frac{\text{kNm}}{\text{m}'} \geq m_{x,B,max} \text{ ok}$$

- Minimum reinforcement in η -direction:

$$m_{\eta,u} \cong 120 \frac{\text{kNm}}{\text{m}'} \geq m_{\eta,max} \text{ ok}$$

- Upper reinforcement: Minimum reinforcement $\left(m'_{xu} = m'_{\eta,u} = 120 \frac{\text{kNm}}{\text{m}'} \right)$

- o Strong band:

$$M_{x,C,max} = 598\text{ kNm}$$

Choice: $8\varnothing 26$, $A_s = 4248\text{ mm}^2$, $d_c = 382\text{ mm}$

$$x = \frac{A_s \cdot f_{sd}}{0.85 \cdot b_s \cdot f_{cd}} = 127\text{ mm} \rightarrow \frac{x}{d_c} = 0.34 < 0.35 \text{ ok}$$

$$M_{x,u} = A_s \cdot f_{sd} \cdot \left(d_c - \frac{0.85x}{2} \right) = 602\text{ kNm} \geq M_{x,C,max} \text{ ok}$$

Reinf. Layers 1, 4
in direction x

$b' = 1000 \frac{\text{mm}}{\text{m}'}$
SIA 262 4.1.4.2.5

$b_s = 850\text{ mm}$
SIA 262 4.1.4.2.5

- Remark for the strip method with skewed strips

According to the bending structural capacity check, $\sigma_\eta = f_{cd}$, in the compression zone. This results in a principal compressive stress $\sigma_3 > f_{cd}$ (compare the Mohr circles below), which is a violation of the Coulomb failure criterion.

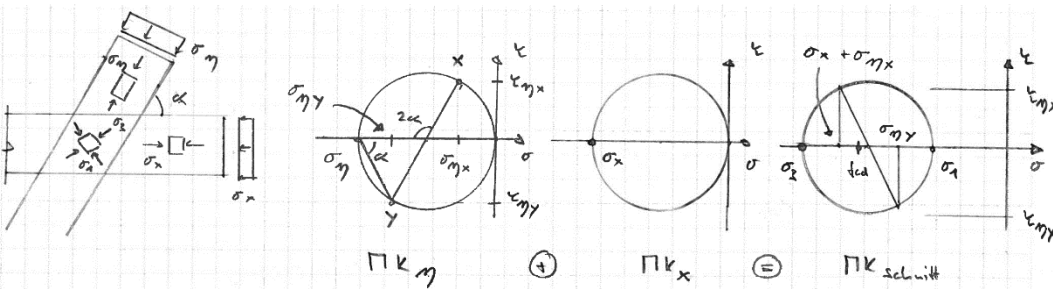

Therefore, the compressive strength f_{cd} of the strips needs to be reduced as a function of the angle α . The check, however, is accepted due to two reasons:

1. The bending resistance has reserves (80% in η -direction).
2. Experimental work shows that concrete under bi-axial loading has a higher strength than under axial loading. Consequently, the check $f_c(\sigma_1) \geq \sigma_3$ should be performed.

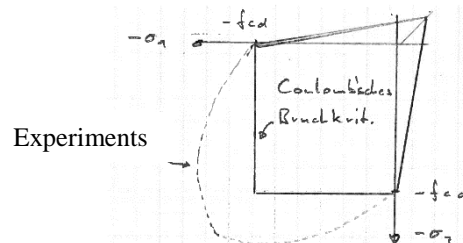

- Check of the shear capacity

Principle shear force with skewed strips:

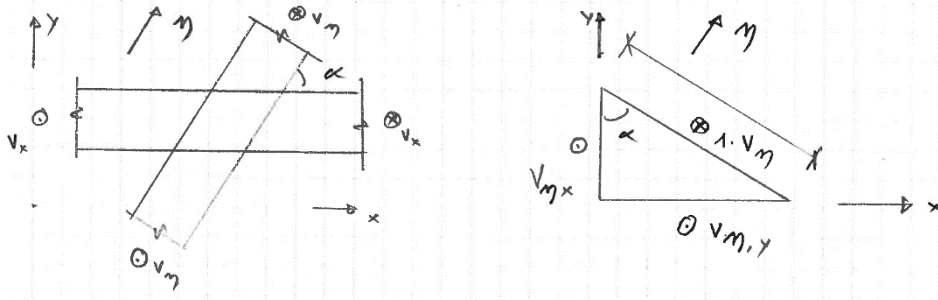

$$\text{Decomposition of } v_n: v_{n,x} = v_n \cdot \cos \alpha, \quad v_{n,y} = v_n \cdot \sin \alpha$$

$$\text{Superposition: } v_{x,tot} = v_x + v_n \cdot \cos \alpha, \quad v_{y,tot} = v_n \cdot \sin \alpha$$

$$\text{Principal shear force: } v_0 = \sqrt{v_{x,tot}^2 + v_{y,tot}^2}$$

$$\text{Principal direction: } \tan \phi_0 = \frac{v_{y,tot}}{v_{x,tot}}$$

$$\text{Shear resistance without shear reinforcement } v_{Rd,ur} = k_d \tau_{cd} d_v = 0.45 \cdot 1.1 \text{ MPa} \cdot 380 \text{ mm} = 188 \frac{\text{kN}}{\text{m}'}$$

$$\text{With: } k_d = \frac{1}{1 + \varepsilon_v d k_g} = \frac{1}{1 + 0.0032 \cdot 380 \cdot 1} = 0.45 \quad \left(\varepsilon_v = 1.5 \frac{f_{sd}}{E_s} = 0.0032; k_g = 1 \right)$$

- Check section B-B close to the strong band:

$$v_{x,B,max} = 189 \frac{\text{kN}}{\text{m}'}$$

$$v_{n,Ad} = 12.2 \frac{\text{kN}}{\text{m}'} v_{n,x} = 12.2 \cdot \cos 60^\circ = 6 \frac{\text{kN}}{\text{m}'}, \quad v_{n,y} = 12.2 \cdot \sin 60^\circ = 11 \frac{\text{kN}}{\text{m}'}$$

$$v_0 = \sqrt{(189 + 6)^2 + 11^2} = 195 \frac{\text{kN}}{\text{m}'} \geq v_{Rd,ur}$$

In this section, shear reinforcement is necessary.

(Strictly speaking, it would be admissible to carry out the check in a section $d_v/2$ away from the support, but in case of doubt, it is always advisable to place shear reinforcement.)

$$v_{Rd,min} = 438 \frac{\text{kN}}{\text{m}'} \geq v_0 = 195 \frac{\text{kN}}{\text{m}'}$$

The minimum shear reinforcement is sufficient and will be placed up to 2 m away from the support (in x -direction).

- Check section C-C:

$$v_{x,C,max} = 281 \frac{\text{kN}}{\text{m}'}$$

$$v_{n,Ad} = 12.2 \frac{\text{kN}}{\text{m}'} v_{n,x} = 12.2 \cdot \cos 60^\circ = 6 \frac{\text{kN}}{\text{m}'}, \quad v_{n,y} = 12.2 \cdot \sin 60^\circ = 11 \frac{\text{kN}}{\text{m}'}$$

$$v_0 = \sqrt{(281 + 6)^2 + 11^2} = 287 \frac{\text{kN}}{\text{m}'} \geq v_{Rd,ur}$$

In this section, shear reinforcement is necessary.

$$v_{Rd,min} = 438 \frac{\text{kN}}{\text{m}'} \geq v_0 = 287 \frac{\text{kN}}{\text{m}'}$$

The minimum shear reinforcement is sufficient and will be placed up to 2 m away from the support (in x -direction).

d) Dimensioning of the slab with CEDRUS 7

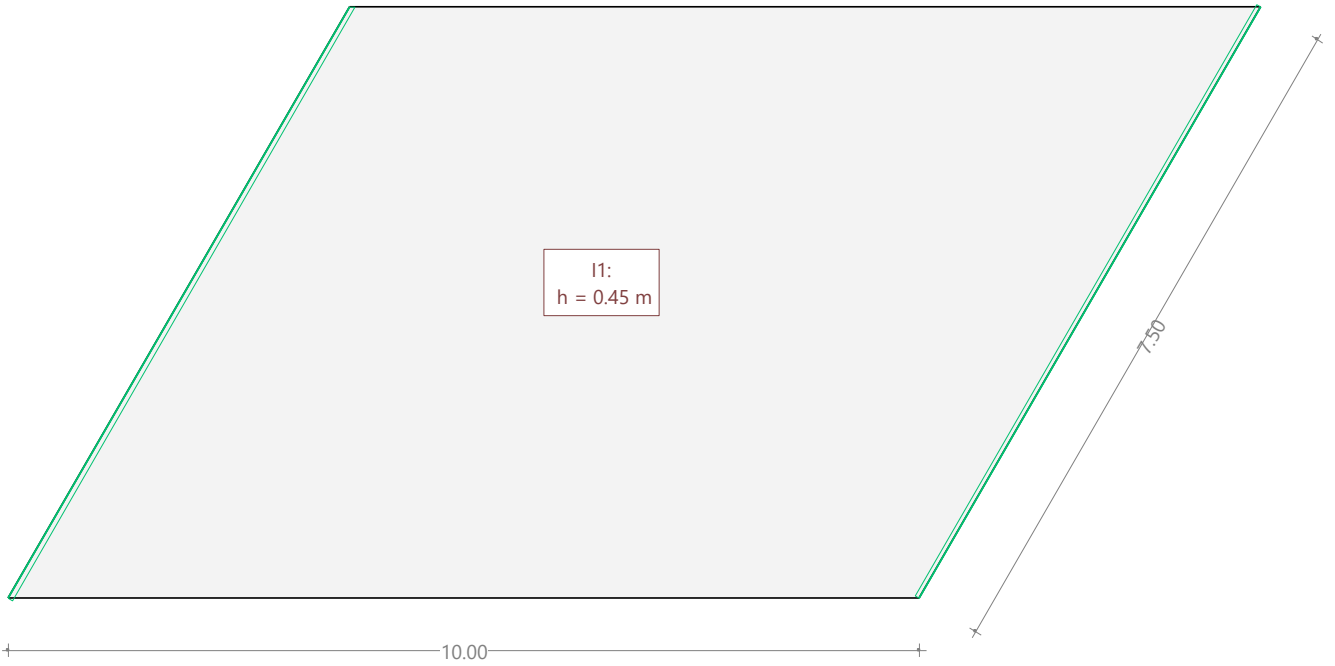

Figure 1: Geometry of the slab in CEDRUS-7



Figure 2: Permanent loads



Figure 3: Live loads

Result combinations

Result combination ULS(d)

Id Load	Factor	Description
EG	1.350	Dead weight
AL	1.350	Non-structural dead weight
NL	1.500	Live load

Specification of the limit state: SLS(quasi-permanent)

Description

Standard-dimensioning situation: Serviceability quasi-permanent combination

Load combinations (quasi-permanent)

Load Nr	Name	Fac	Load combination 1
1	Dead weight	1	1
2	Non-structural d.w.	1	1
3	Live loads	1	0.6

Fac : all combination values are multiplied with this factor

Load combinations (frequent)

Load Nr	Name	Fac	Load combination 1
1	Dead weight	1	1
2	Non-structural d.w.	1	1
3	Live loads	1	0.7

Fac : all combination values are multiplied with this factor

Load superposition

Load	additive	exclusiv	Load	Factor	Komb.
Dead weight	permanent		EG	1.000	
Non-structural d.w.	permanent		AL	1.000	
Live loads	where decisive		NL	1.000	

(translated, not the original)

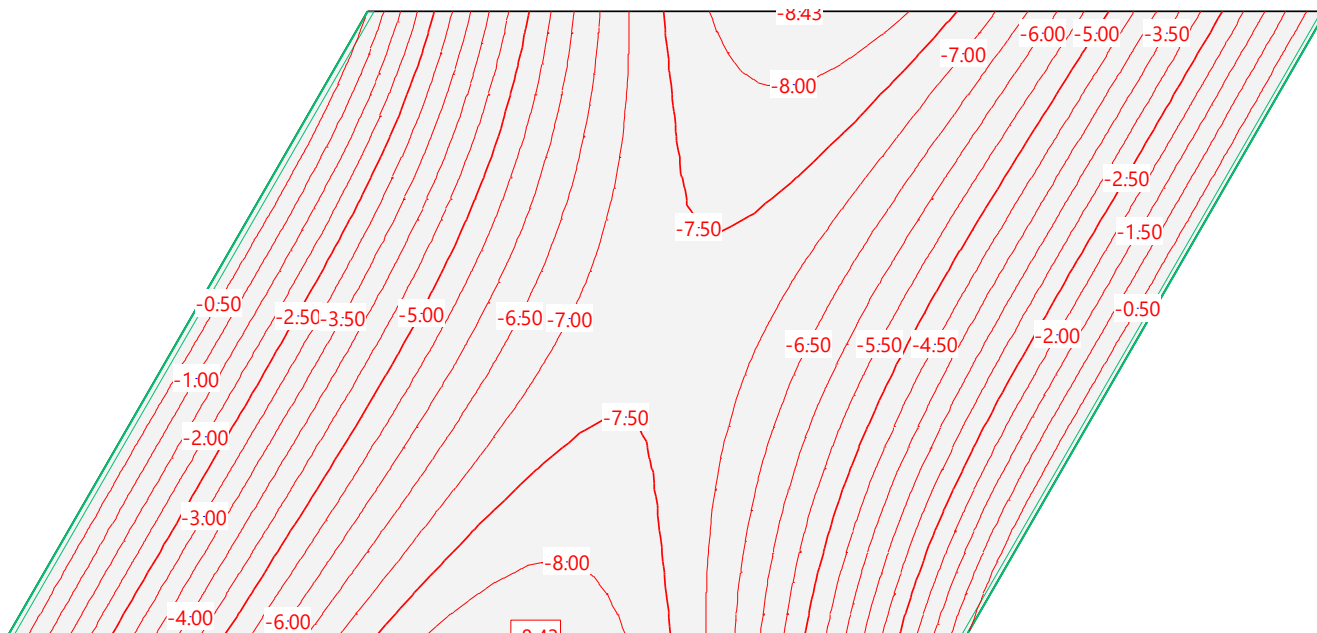

Figure 4: Elastic deformation for limit state quasi-permanent

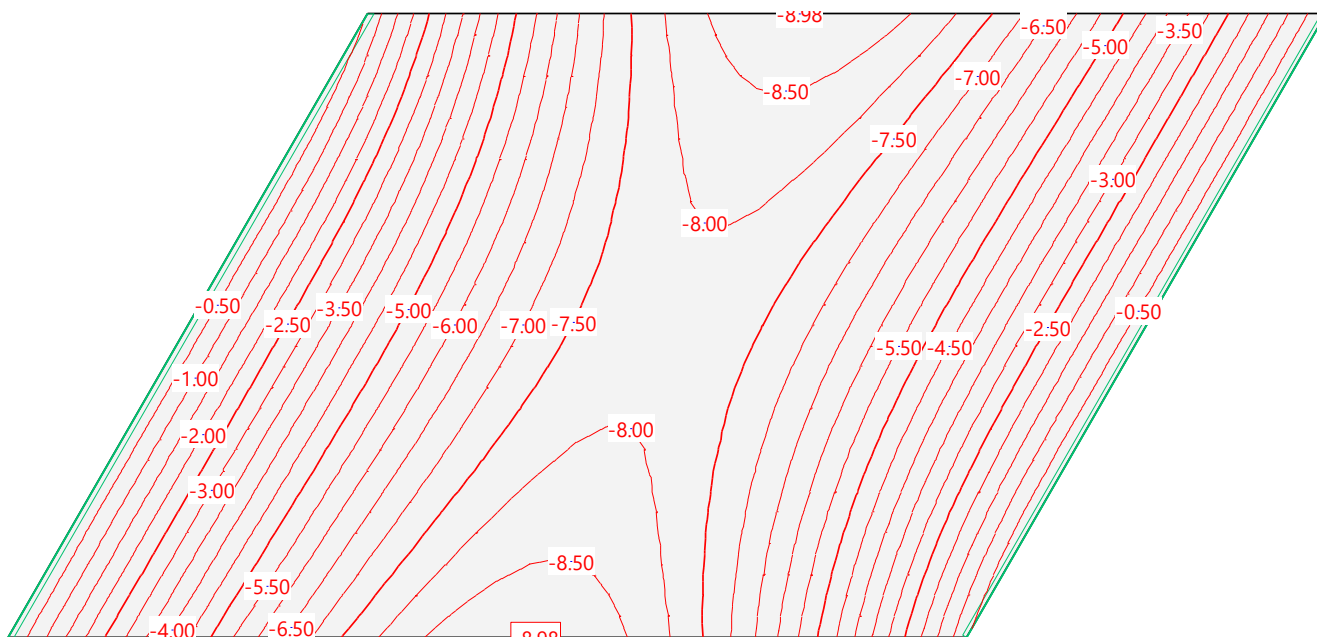

Figure 5: Elastic deformation for limit state frequent

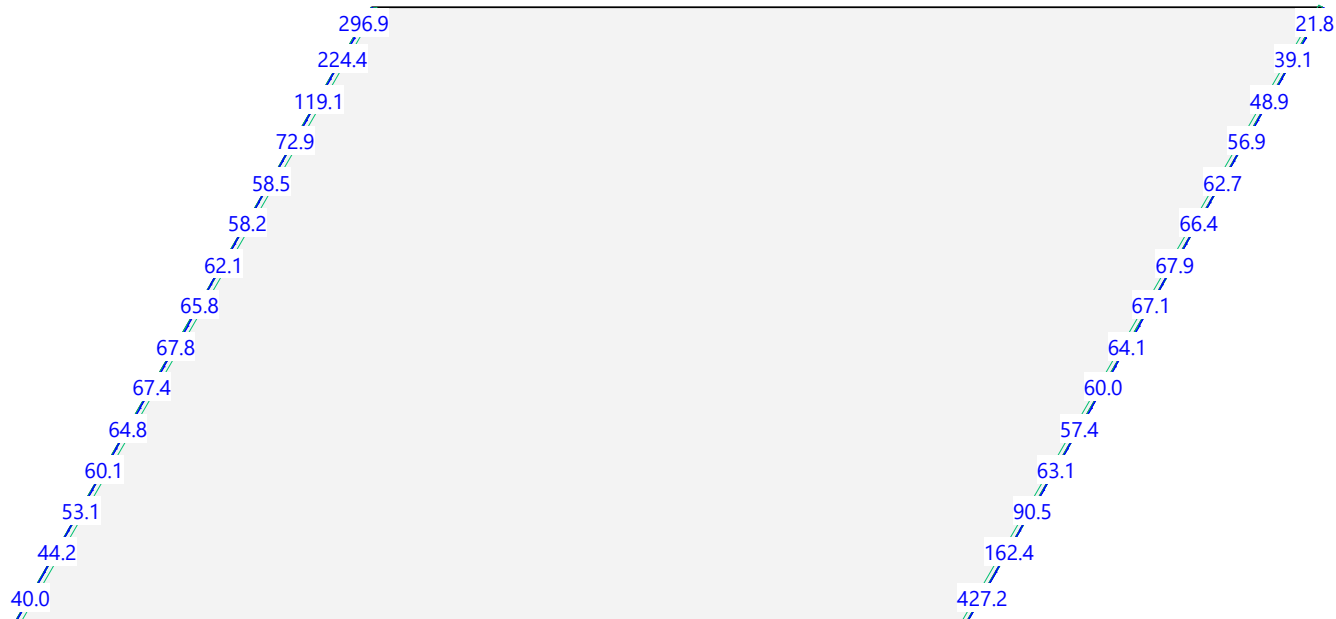

Figure 6: Support forces for ULS(d) [kN]

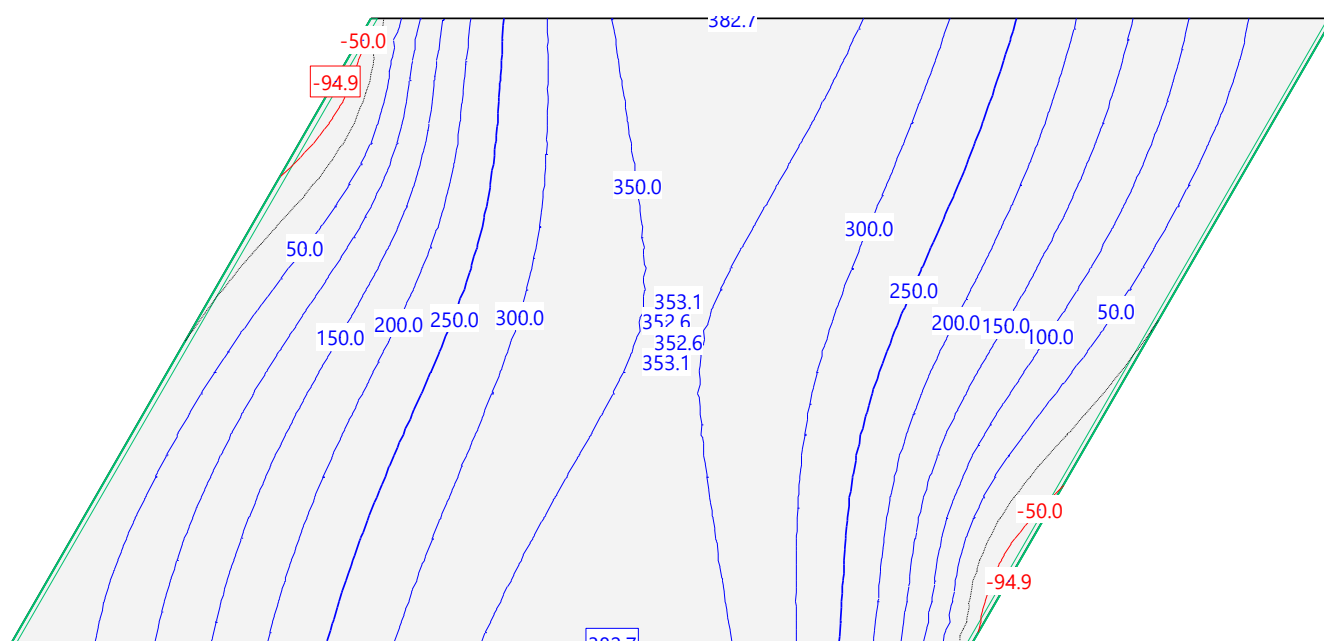

Figure 7: Internal force m_x for ULS(d) [kNm/m]

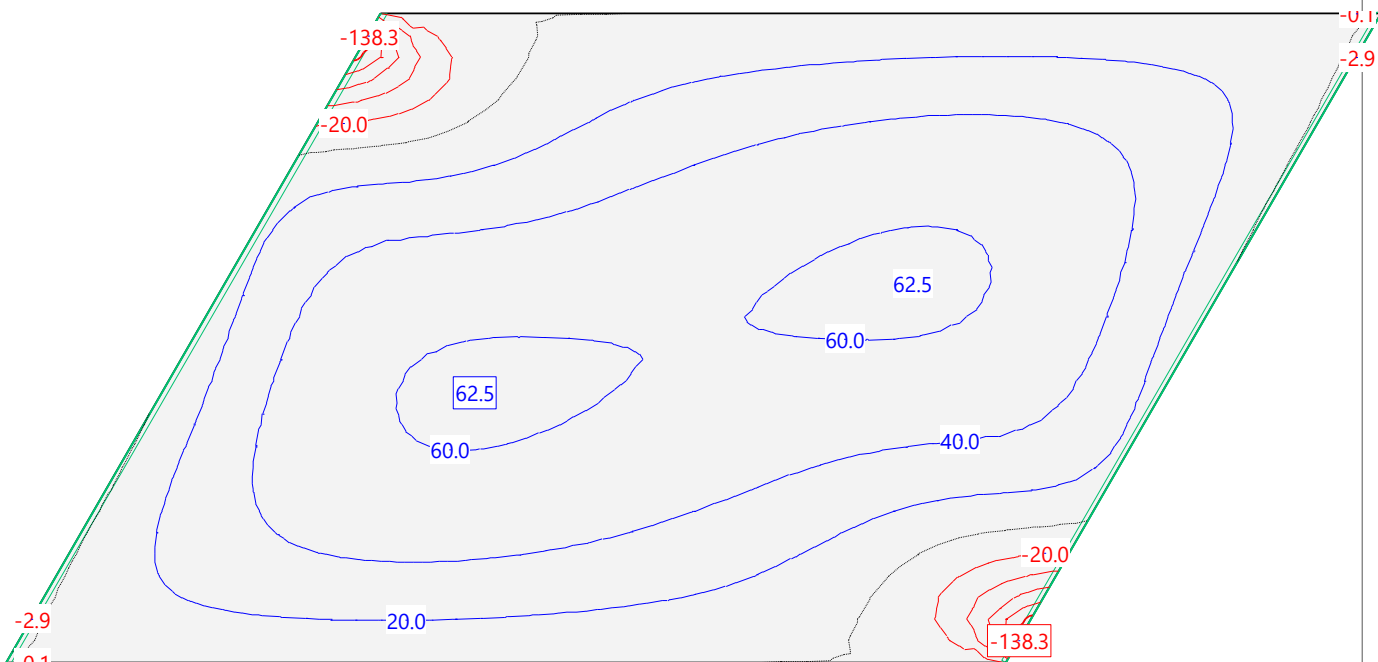

Figure 8: Internal force m_y for ULS(d) [kNm/m]

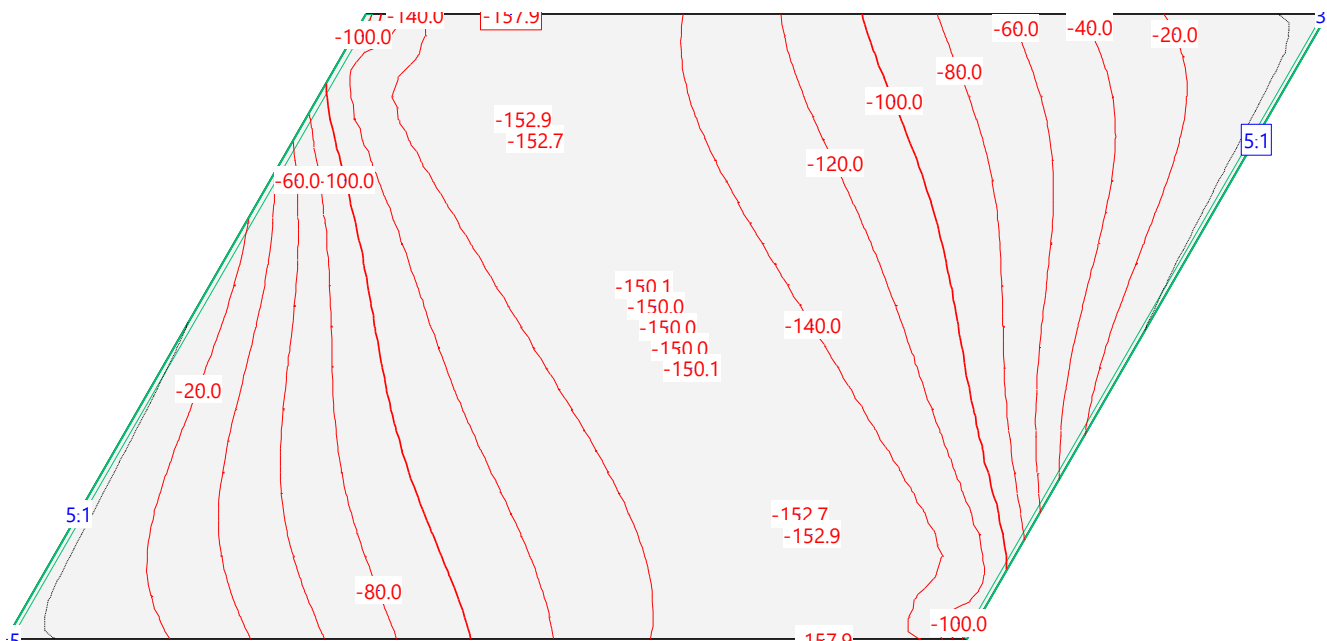

Figure 9: Internal force m_{xy} for ULS(d) [kNm/m]

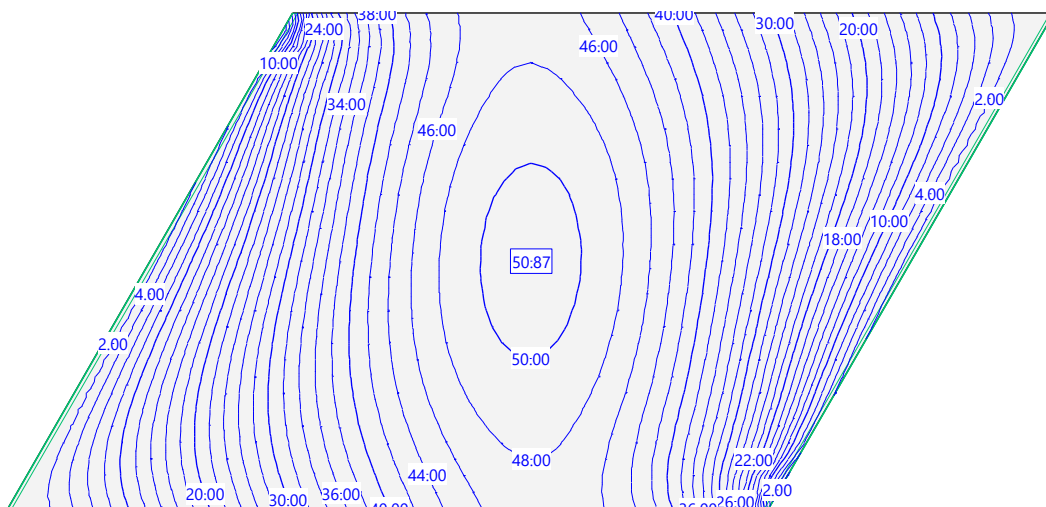

Figure 10: Cross-sections for the lower reinforcement [cm²/m] in x-direction, contour lines at 2 [cm²/m], scale 1:100

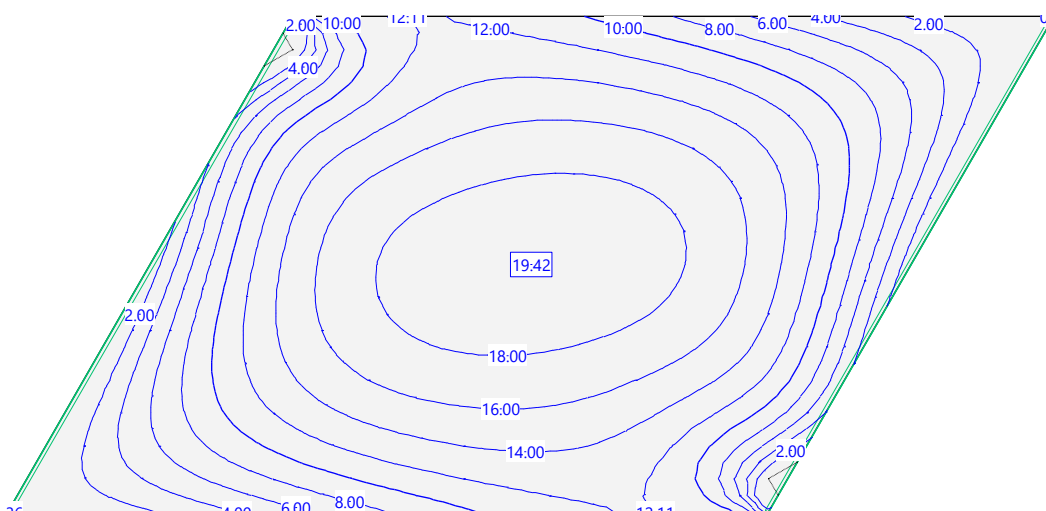

Figure 11: Cross-sections for the lower reinforcement [cm²/m] in η-direction, contour lines at 2 [cm²/m], scale 1:100

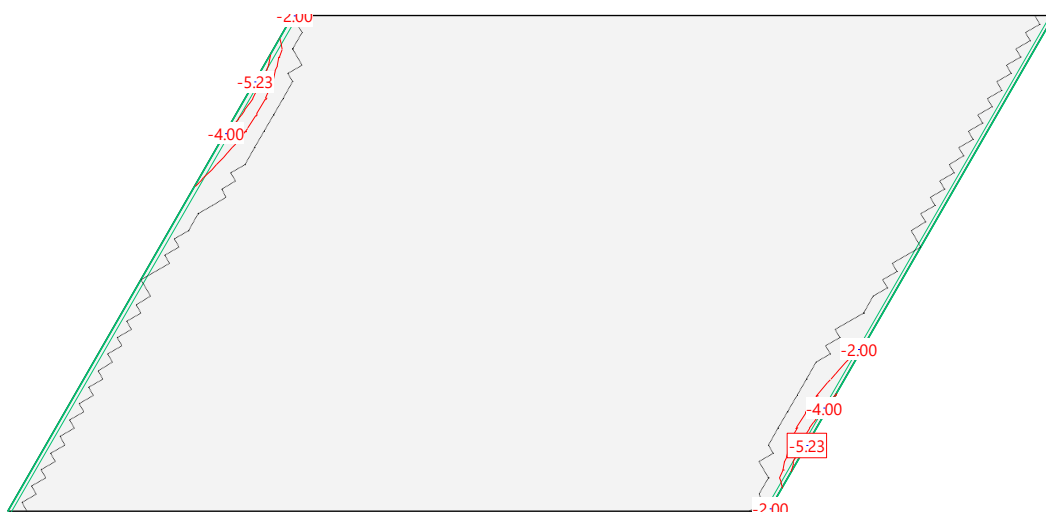

Figure 12: Cross-sections for the upper reinforcement [cm²/m] in x-direction, contour lines at 2 [cm²/m], scale 1:100

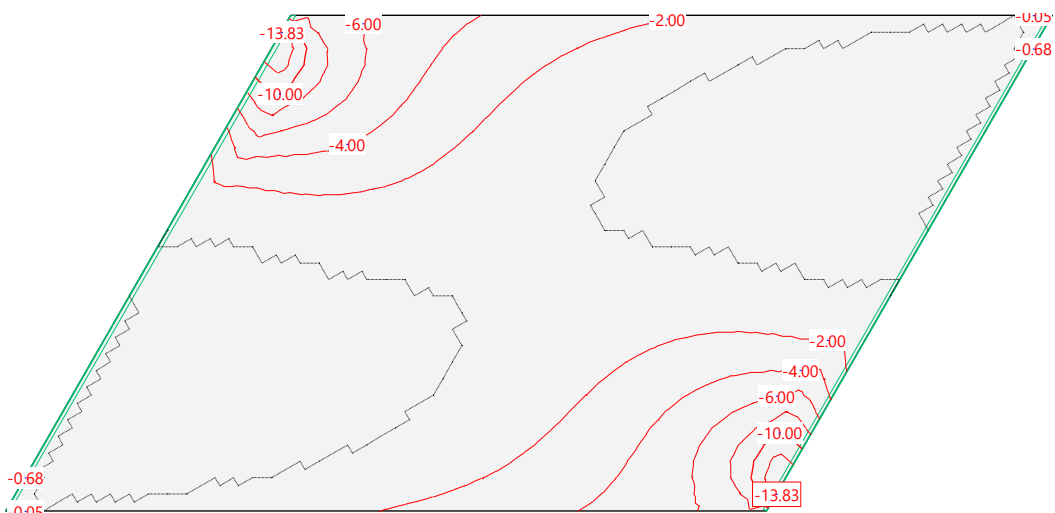

Figure 13: Cross-sections for the upper reinforcement [cm^2/m] in η -direction, contour lines at 2 [cm^2/m], scale 1:100

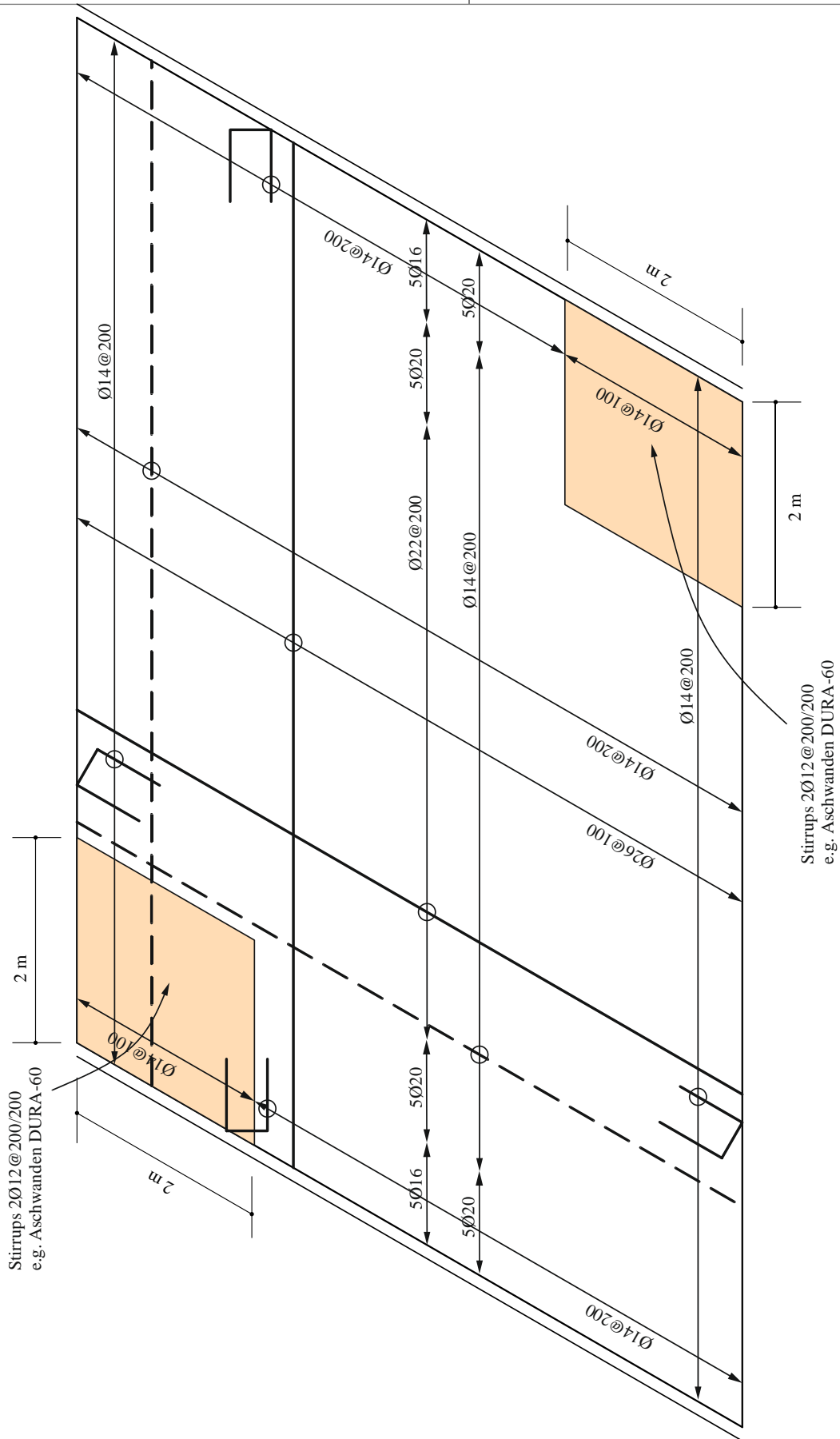

Figure 14: Reinforcement layout for the FEM calculation

f) Upper limit value of the ultimate load

External work: $W = q_{ud} \cdot 10\text{m} \cdot 7.5\text{m} \cdot \sin(60^\circ) \cdot 1 \cdot \frac{1}{2} = 32.5\text{m}^2 \cdot q_{ud}$

Dissipation (Internal) work:

Generally: $dD = m_{nu} \cdot \dot{\omega}_n \cdot dt$ (while: $\underline{n} \perp \underline{t}$)

Alternative 1:

Separating in x-η-direction:

$dD = m_{xu} \cdot \dot{\omega}_x \cdot dy + m_{\eta u} \cdot \dot{\omega}_\eta \cdot d\xi$ (projected length of the yield line onto each axis)

Since the yield line is parallel to the η-direction: $\dot{\omega}_\eta = 0$ and therefore:

$D = D_x = \int_0^{6.5} m_x \cdot \dot{\omega}_x \cdot dy = 726 \frac{\text{kNm}}{\text{m}} \cdot \frac{2}{5\text{m}} \cdot \cos(30^\circ) \cdot 7.5\text{m} = 1888 \frac{\text{kNm}}{\text{m}}$

with $m_{xu} = a_{sx} \cdot f_{sd} \left(d - \frac{a_{sx} \cdot f_{sd}}{2 \cdot b \cdot f_{cd}} \right) = 726 \frac{\text{kNm}}{\text{m}}$, $d = 450 - c_{nom} - \varnothing_s - \frac{\varnothing}{2}$

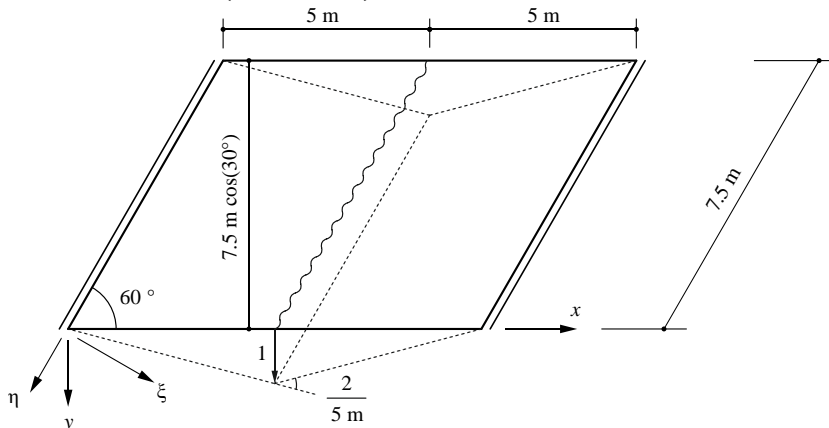

Alternative 2:

Consider $n = \xi$: $dD = m_{\xi u} \cdot \dot{\omega}_\xi \cdot d\eta = \mu_\xi \cdot \dot{\omega}_\xi \cdot d\eta$

Transformation of the reinforcement in directions ξ-η

$\mu_\xi = m_{xu} \cdot \cos^2(-30^\circ) + m_{\eta u} \cdot \cos^2(-90^\circ) = m_{xu} \cdot \cos^2(30^\circ)$

Rotation of the yield line: $\dot{\omega}_\xi = \frac{2}{5 \cos(30^\circ)}$

$D = D_x = \int_0^{7.5} \mu_\xi \cdot \dot{\omega}_\xi \cdot d\eta = \int_0^{7.5} m_{xu} \cdot \cos^2(30^\circ) \cdot \frac{2}{5 \cos(30^\circ)} d\eta = 726 \frac{\text{kNm}}{\text{m}} \cdot \cos(30^\circ) \cdot \frac{2}{5\text{m}} \cdot 7.5\text{m} = 1888 \frac{\text{kNm}}{\text{m}}$

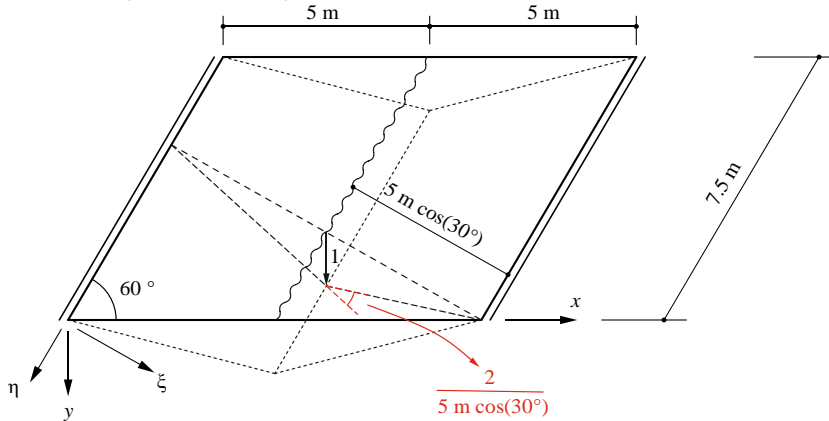

$W = D \rightarrow q_{ud} = \frac{1888 \frac{\text{kNm}}{\text{m}}}{32.5\text{m}^2} = 58.1 \frac{\text{kN}}{\text{m}^2} > q_d$ ok

$a_{sx} = 5309 \frac{\text{mm}^2}{\text{m}}$

(p.14)

$\varnothing_s = 10\text{mm}$

$\varnothing = 26\text{mm}$

$c_{nom} = 55\text{mm}$

Advanced Structural Concrete		16/16
Exercise 3	Solution	hs/mle/lg

g) Discussion

- **Dimensioning with strip method**

If the slab is dimensioned using the simple strip method, which neglects the occurrence of twisting moments, a lower limit value of the load results according to the static limit value theorem of the theory of plasticity. With a simple manual calculation, for example, an FEM calculation can be checked for plausibility or a slab can be dimensioned. The last point is valid under the condition that the detailing of reinforcement guarantees a ductile behaviour of the slab.

The load transfer alternative selected in task c) does not sufficiently take account of the real load-bearing behaviour of the slab, especially in the obtuse corners. In order for the selected load transfer to occur, a relatively large rearrangement of the internal forces and the associated crack formation are necessary. The serviceability of a bridge can be impaired by such crack formation.

- **Dimensioning with FEM**

The FEM calculation also results in a possible equilibrium state (lower limit value of the load), but at the same time considers the compatibility in the homogeneous-elastic state. Due to crack formation in the serviceability limit state as well as restraints, which practically cannot be calculated, the internal forces are redistributed. The actual force flow thus also deviates from that of the calculation, but the load-bearing behaviour can be approximated more accurately overall.

The consideration of twisting moments results in higher reinforcement ratios than with the strip method. The required amount of reinforcement would be reduced if the bars were laid in the direction of the main moments. However, this procedure is not appropriate for installation purposes.

- **Check with yield line method**

The yield line method is an application of the kinematic method of the theory of plasticity and results in an upper limit value for the ultimate load. It is therefore suitable for the inspection of existing slabs or the plausibility check of a lower limit value. By varying the failure mechanisms, the calculated upper limit value can be minimized. The mechanism considered in task f) is suitable for a manual calculation based on its very simple geometry. In this case, it leads to the same load as in the strip method when the uniaxial load transfer is selected. Thus, this represents the complete solution. As for the elastic internal forces, large plastic deformations would be necessary to reach this failure state. Redistributions within the plate are necessary. While this may still be possible for the bending moments (whereby the proof of the deformability is extremely difficult since the system is statically indeterminate), it is to be expected that a brittle failure occurs beforehand, in particular as a result of the shear force. Since larger cracks should also be avoided at the serviceability limit state, it is recommended that the reinforcement is dimensioned following the elastic internal forces as much as possible.