

# 2 In plane loading

## 2.6 Numerical modelling

In this chapter we discuss how the mechanical models that have been introduced in the previous chapters can be used in numerical approaches that allow for a more efficient structural design. A profound knowledge of the underlying methods and their limits of applicability is essential for a safe and correct application of numerical models. The engineer should always keep the control over the design and understand the behaviour of the structure despite using any kind of software for structural analysis or design.

## Learning objectives

Within this chapter, the students are able to:

- select the most suitable numerical model for each structural concrete problem, clearly differentiating design and assessment-oriented approaches.
  - recognise the higher probability of making mistakes when increasing modelling complexity and the necessity to cross-check numerical models' results with simple handmade analysis.
  - identify how to discretise a structural member with a combination of spine, planar, multilayer and three-dimensional elements.
  - discuss the workflow of selected numerical models.
- recall the main assumptions of the Compatible Stress Field Method, its range of applicability and the similitudes and differences to already studied equilibrium and compression field approaches.

# Introduction

## Levels of Approximation (LoA)

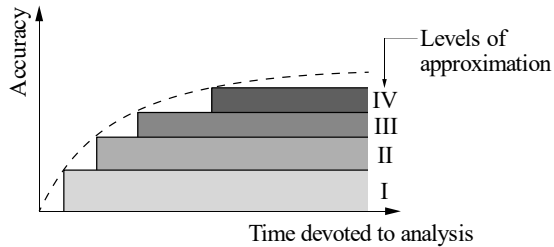

[Muttoni, 2018]

- From simple analyses (handmade) to nonlinear calculations (specific software)
- With every new LoA the knowledge on the behavior of the structure increases
- While a low LoA tends to be conservative, a higher LoA does not always predict a higher load (hidden brittle mechanisms can be captured with high LoA)
- More complex models also increase the probability of making a modelling mistake → engineer should always cross check with simple hand calculations!

In order to keep full control over the design, engineers should avoid using numerical models alone but follow what is called a progressive level of approximation (LoA) approach. While with increasing LoA the knowledge on the behavior of the structure potentially increases, the probability of making a modelling mistake also increases.

# Introduction

## Modelling of structures

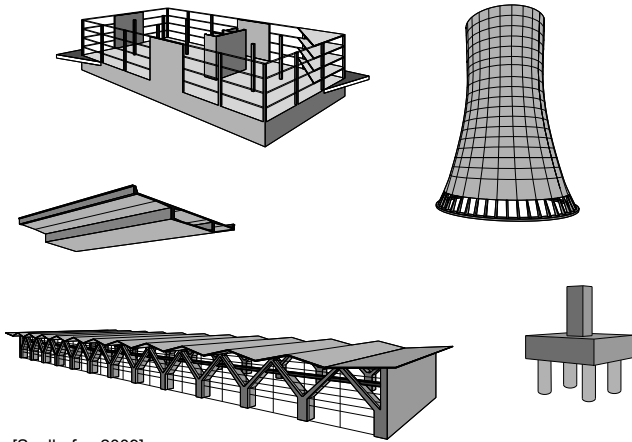

[Seelhofer, 2009]

Structures can be modelled with linear or non-linear approaches and with

- 1D elements (spine)
- 2D elements
- 2D multilayer elements
- 3D elements

Depending on their geometry, concrete structures can be modelled with different elements. In general, structures are three-dimensional but can be usually discretised with multiple elements of simpler geometry (as e.g. when using the Finite Element Method). The following slides give an overview of the most frequent elements for modelling concrete structures. Independently of the geometry of the modelling element, it is important to distinguish the following two approaches to calculate the internal forces of the structure:

- **Linear elastic approaches:** In this case the internal forces are calculated assuming a linear elastic behaviour of the structure (i.e. only the concrete geometry has to be known). Based on the calculated internal forces, the reinforcement can be designed and the concrete can be checked using limit analysis methods (e.g. cross section design, membrane yield conditions or sandwich model). It should be noted that the material is modelled as non-linear in the later design step (either rigid-perfectly plastic or fully non-linear idealisations can be used depending whether hand calculations or numerical approaches are used).
- **Non-linear approaches:** In order to get a more profound or accurate knowledge of the behaviour, it is possible to account for the non-linear behaviour of the materials when computing the internal forces. This requires knowing both the concrete geometry and the reinforcement a priori. This is the case for an assessment task in which the structural behaviour is analysed. Non-linear approaches can still be applied when designing new structures, in order to analyse a pre-design conducted with an approach with a lower level of approximation.



# Introduction

## Modelling of structures

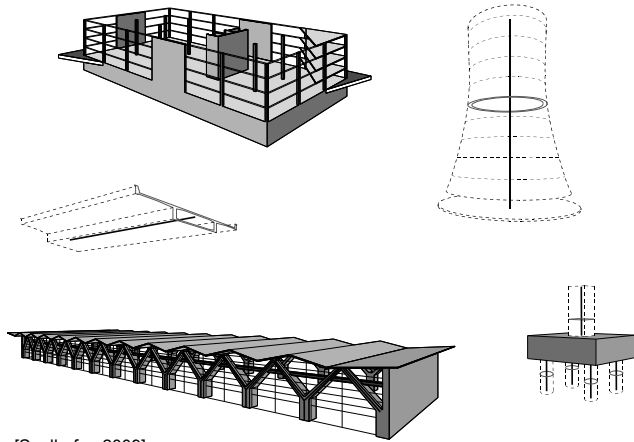

[Seelhofer, 2009]

Structures can be modelled with linear or non-linear approaches and with

- 1D elements (spine)
- 2D elements
- 2D multilayer elements
- 3D elements

In many structural members one of the dimensions is significantly higher than the others. In these cases, it is possible to model the global structural behaviour with a spine model in which each point represents the main properties of the cross section (e.g. stiffness). While this model is sufficiently accurate in many cases, a more profound knowledge of the structural behaviour can be achieved in some structural elements by modelling with 2D plane elements.

# Introduction

## Modelling of structures

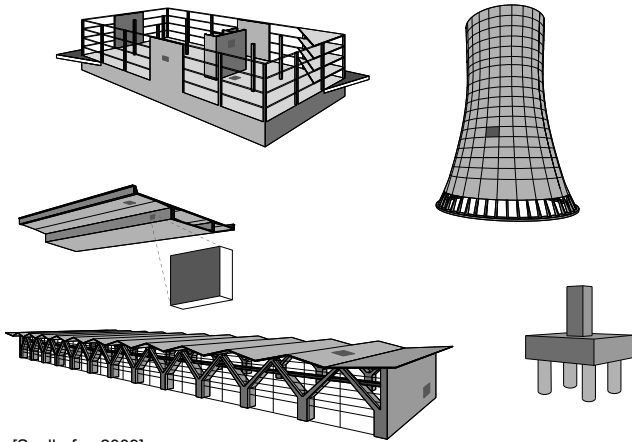

[Seelhofer, 2009]

Structures can be modelled with linear or non-linear approaches and with

- 1D elements (spine)
- 2D elements
- 2D multilayer elements
- 3D elements

Many concrete structures can be modelled with 2D planar elements. These elements can be assembled with local or gradual folds in order to model curved or folded structures. It should be noted that while the box girder bridge shown in the slide can be modelled with 1D elements, the use of 2D folded elements allows for a more precise analysis of the structural behaviour, including local effects.

# Introduction

## Modelling of structures

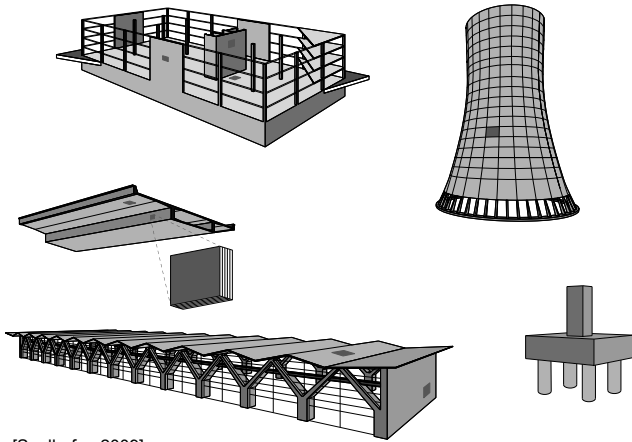

[Seelhofer, 2009]

Structures can be modelled with linear or non-linear approaches and with

- 1D elements (spine)
- 2D elements
- 2D multilayer elements
- 3D elements

In 2D elements subjected to general shell loading (in-plane normal and shear forces, as well as transversal loading, i.e. bending moments, transversal shear and drilling moments) a modelling approach with 2D elements composed of several linked layers is often used. This way, the general loading actions can be decomposed in an in-plane loading state in each of the layers.

# Introduction

## Modelling of structures

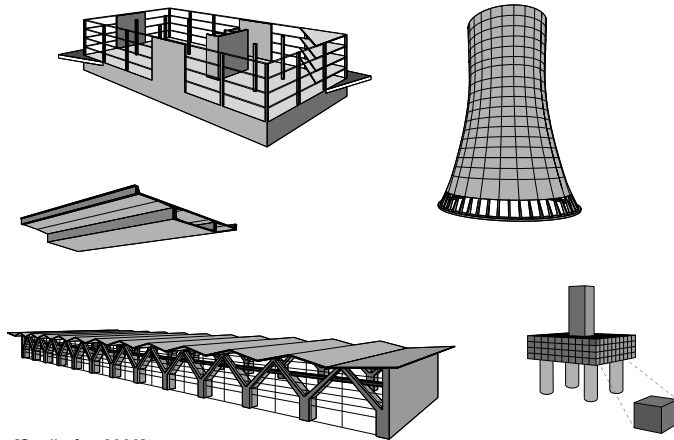

[Seelhofer, 2009]

Structures can be modelled with linear or non-linear approaches and with

- 1D elements (spine)
- 2D elements
- 2D multilayer elements
- 3D elements

Some structural elements, as e.g. the pile cap shown in the slide, have a three-dimensional geometry and can usually not be modelled with 1D or 2D elements. While the internal forces can be calculated in a linear elastic approach using brick elements, there is a lack of numerical models to design or assess the behaviour of three-dimensional concrete structures in a consistent and reliable way. The design of such elements is still done mostly by means of strut-and-tie model and stress field hand calculations. Some of these calculations are implemented in structural software for the most frequent 3D structural members, but this software does not allow the calculation of general 3D problems.

# Overview of numerical models for structural design and analysis

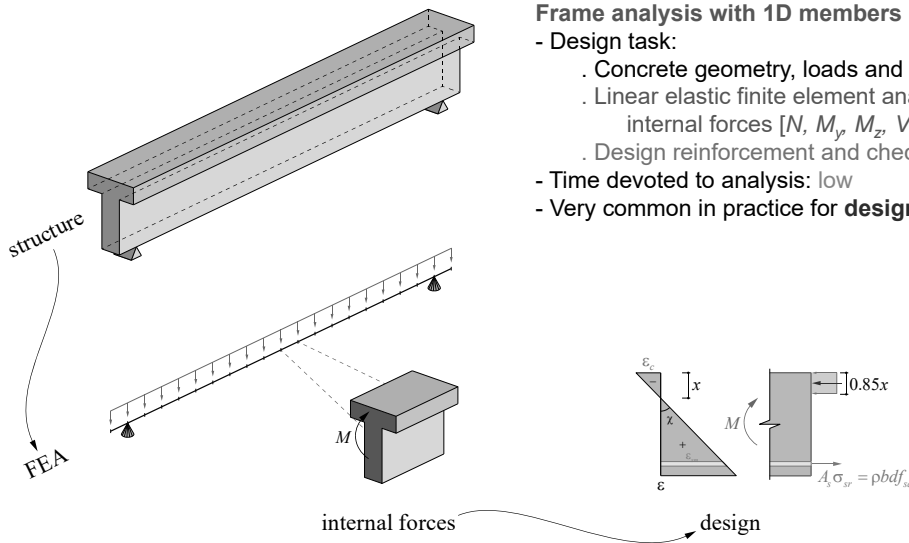

## Frame analysis with 1D members + cross section design

- Design task:
  - . Concrete geometry, loads and boundary conditions are known
  - . Linear elastic finite element analysis (FEA) to determine internal forces  $[N, M_y, M_z, V_y, V_z, T_x]$
  - . Design reinforcement and check concrete
- Time devoted to analysis: low
- Very common in practice for **design**, commercial software available

The following slides provide an overview of the most common numerical models used for designing and assessing concrete structures. This does not intend to be a detailed list of available methods, since the offer of structural software is large, but to give a critical overview of possibilities with different levels of approximation.

## Frame analysis of 1D members + cross section design:

The cross sectional design is the most widespread method for designing concrete structures. While this approach is typically applied by hand calculations, it is also implemented in many commercial software packages. The internal forces of the structure are calculated in a first step by assuming typically linear elastic material behaviour. In this way only the concrete geometry, loads and boundary conditions have to be known beforehand. In a second step, each cross section is designed (required reinforcement is calculated and concrete strength is verified) according to the limit analysis of the theory of plasticity. The parabolic-rectangular idealisation of concrete and the linear-elastic-perfectly plastic idealisation of the reinforcement (i.e. non-linear behaviour of the materials) are the most common material constitutive laws implemented in numerical approaches. It should be noted that cross-sectional design methods are only applicable where the Bernoulli hypothesis (plane sections remain plain after deforming) is valid (i.e. regions with smooth variations of the geometry and without concentrated loads). Parts of structures with static and/or geometric discontinuities (D-regions) cannot be designed with this approach.

# Overview of numerical models for structural design and analysis

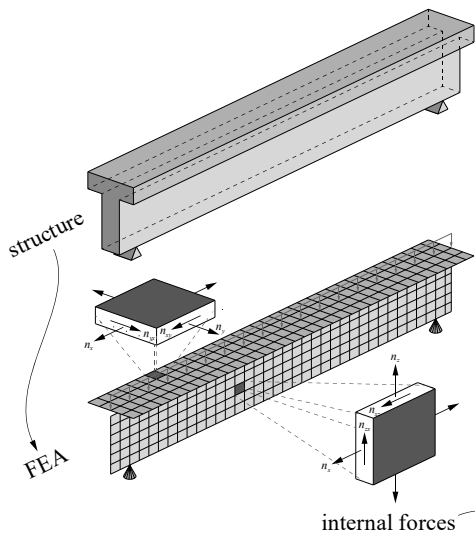

## 2D analysis + design with membrane yield conditions

- Design task:
  - . Concrete geometry, loads and boundary conditions are known
  - . Linear elastic finite element analysis (FEA) to determine internal forces  $[n_x, n_z, n_{xz}]$  (elements with only membrane loading)
  - . Design reinforcement with yield conditions ( $k=1$ ) and check concrete
- Time devoted to analysis: low
- Common in practice for **design**, commercial software available

$$Y_1 = n_{xz}^2 - (a_{sx}f_{sx} - n_x)(a_{sz}f_{sz} - n_z) = 0$$

$$k = \cot \alpha \rightarrow \begin{cases} a_{sx}f_{sx} \geq n_x + k|n_{xz}| \\ a_{sz}f_{sz} \geq n_z + k^{-1}|n_{xz}| \end{cases}$$

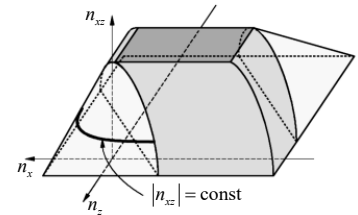

## 2D analysis + design with membrane yield conditions:

The reinforcement of structures modelled with 2D elements can be easily designed by using the membrane yield conditions already presented in the course, in the case of structure subjected exclusively to membrane loading (in-plane loading). The procedure is analogous to the cross sectional design of 1D members. First, the membrane forces are calculated typically with linear elastic Finite Element Analysis and then the limit analysis membrane yield conditions (rigid-ideal plastic material idealisation, i.e. non-linear behaviour) are used for the structural design. The linearised yield conditions in Regime 1 (i.e. assuming  $\cot \alpha = 1$ ) are frequently implemented in commercial software. However, it should be noted that dimensioning in Regime 2 is also possible for webs of beams. The effective compressive strength should be carefully selected by the engineer in order to guarantee safe designs. Similarly as for cross sectional design methods, the design with membrane yield conditions is, strictly speaking, not applicable to those parts of the structures with static and/or geometric discontinuities (D-regions).

The design of many members (as e.g. beams or deep beams) with yield conditions often leads to impractical and expensive designs since the non-symmetric strength of concrete is only accounted for in the last dimensioning step. In such elements it is preferred to account for the non-linear material behaviour when calculating the internal forces (as typically done with stress fields hand calculations or with non-linear numerical approaches).

# Overview of numerical models for structural design and analysis

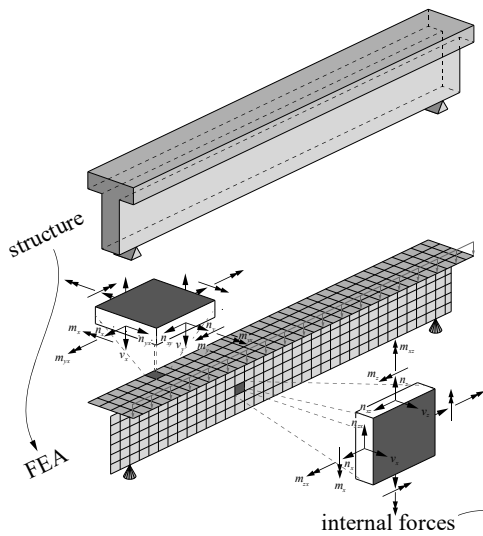

## 2D analysis + sandwich model + design with membrane yield conditions of outer layers

- Design task:

- . Concrete geometry, loads and boundary conditions are known
- . Linear elastic finite element analysis (FEA) to determine internal forces  $[n_x, n_z, n_{xz}, m_x, m_z, m_{xz}, v_x, v_z]$  (elements with general shell loading)
- . Transformation of the general shell loading to the sandwich model
- . Design reinforcement in the outer layers with yield conditions ( $k=1$ ) and check concrete

- Time devoted to analysis: medium

- Common in practice for **design**

$$Y_1 = n_{xz}^2 - (a_{sx} f_{sx} - n_x)(a_{sz} f_{sz} - n_z) = 0$$

$$k = \cot \alpha \rightarrow \begin{cases} a_{sx} f_{sx} \geq n_x + k |n_{xz}| \\ a_{sz} f_{sz} \geq n_z + k^{-1} |n_{xz}| \end{cases}$$

internal forces → sandwich model → design

## 2D analysis + sandwich model + design with membrane yield conditions of outer layers:

In case the structural analysis with 2D elements yields not only membrane loading but a general shell loading state (e.g. in slabs or 1D members subjected to non-symmetric loading cases that result in transverse bending) the design with membrane yield conditions is still possible. Similarly as in elements subjected only to in-plane loading, the internal forces are calculated in a first step typically with linear elastic Finite Element Analysis, which only require the concrete geometry, loads and boundary conditions to be known. In a second step, the sandwich model can be applied in order to transform the general shell loading in two states of membrane loading in the outer layers. This method will be presented in detail in the chapter about slabs. The outer layers can be designed in the same way as presented in the previous slide using the limit analysis membrane yield conditions (rigid-ideal plastic material idealisation, i.e. non-linear behaviour). All the remarks indicated in previous slide are also applicable in this case.

# Overview of numerical models for structural design and analysis

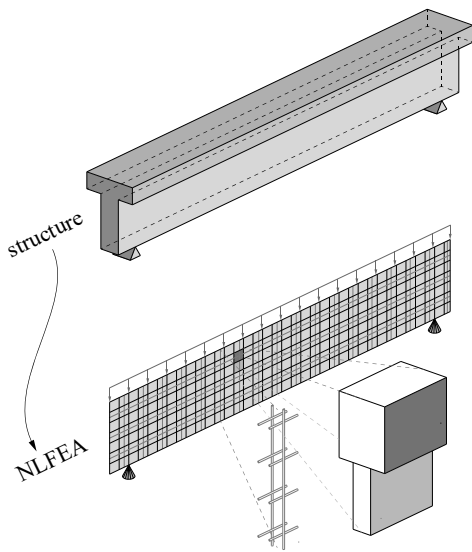

## Compatible Stress Field Method (CSFM)

- Assessment task
    - . Concrete geometry, loads and reinforcement are known
    - . Non-linear finite element analysis (NLFEA)  $\rightarrow \sigma \xleftrightarrow{\varepsilon} \varepsilon$
- constitutive  
relationship
- $\sigma \xleftrightarrow{\varepsilon} \varepsilon$
- Compatible stress fields
  - Structures with only in-plane loading
  - Reinforcement and concrete are modelled separately
  - Suitable for Discontinuity Regions
  - Tension stiffening according to TCM & POM (1D)
- Time devoted to analysis: medium
  - Commercial software available  $\rightarrow$  Idea StatiCa Detail
  - Increasingly used in practice for **assessment** and **design**

13.10.2021

ETH Zurich | Chair of Concrete Structures and Bridge Design | Advanced Structural Concrete

12

This and the next two slides present non-linear approaches for the structural analysis of concrete members. These approaches might provide a more profound or accurate knowledge of the behaviour, as they account for the non-linear behaviour of the materials when computing the internal forces. However, they require knowing both the concrete geometry and the reinforcement a priori. This is the case for an assessment task in which the structural behaviour is analysed. Simplified non-linear approaches, like the Compatible Stress Field Model, can still be applied when designing new structures, in order to refine a pre-design conducted with an approach with a lower level of approximation.

### Compatible Stress Field Method (CSFM):

The Compatible Stress Field Method (CSFM) is an approach for the design and assessment of concrete structures which has been developed in ETH Zurich in collaboration with IDEA StatiCa, to overcome the tedious application of classic design tools by hand calculation, while keeping the advantages of stress fields and strut-and-tie models. This new method is particularly suitable for so-called *discontinuity regions* and is available in the commercial software IDEA StatiCa Detail (free academic licenses can be ordered in <https://www.ideastatica.com/educational-license/>). The approach will be presented in detail later in this chapter.

The CSFM is a simplified non-linear approach in which the concrete tensile strength is not considered in terms of strength (similarly as in standard structural concrete design), but is accounted its influence to the members' stiffness (i.e. tension stiffening) in order to cover all design code prescriptions including serviceability, load-deformation and deformation capacity aspects, not consistently addressed by previous approaches. All the material properties can be automatically generated from the concrete and reinforcement grades, based on the prescriptions of structural design codes.

The concrete and the reinforcement are modelled with different 2D and 1D finite elements respectively that are linked in order to model the bond shear slip transfer. Therefore, both the reinforcement and the concrete should be perfectly known when analysing an structural element.

It should be noted that currently this approach is only suitable for 2D structures subjected only to in-plane loading. Some 3D effects such as flanges can only be modelled by introducing concrete elements of different thicknesses.

Among the presented numerical approaches this is the only one suitable for the verification of hand calculations (strut-and-tie models and stress fields).

While CSFM requires knowing perfectly the reinforcement and the concrete of the structure in order to conduct and analysis, due to the speed of the calculations the method is also used for the design of new structures by using an iterative approach.

Only basic material properties, reinforcement and concrete grade need to be known

The stress field method is applicable for any kind of structure with or without static or geometric discontinuities.



## Overview of numerical models for structural design and analysis

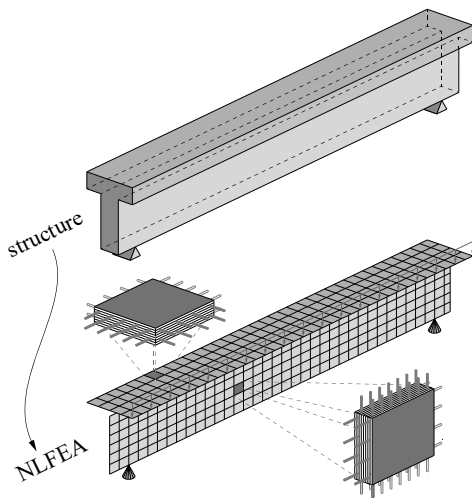

[Thoma, 2018]

### Cracked Membrane Model Usermat (CMM-Usermat)

- Assessment task
  - . Concrete geometry, loads and reinforcement are known
  - . Non-linear finite element analysis (NLFEA) →  $\sigma \xleftrightarrow{\varepsilon} \varepsilon$
  - Compatible stress fields
  - Multilayer shell element
  - Reinforcement and Concrete are modelled as a composite
  - Tension stiffening according to TCM (2D)
- Time devoted to analysis: high
- Used at ETHZ for research and expertise

constitutive  
relationship

$$\sigma \xleftrightarrow{\varepsilon} \varepsilon$$

### Cracked Membrane Model Usermat (CMM-Usermat):

The Cracked Membrane Model with fictitious rotating stress free cracks (CMM-R) was already presented in the previous chapter when introducing the Compression Field Approaches. This model has been implemented as an ANSYS user defined material, which can be applied to analyse structures with 2D elements. The use of a multilayer approach makes it suitable to analyse structures with any kind of loading. Similarly as in the CSFM, all the material properties can be automatically generated from the concrete and reinforcement grades, based on the prescriptions of structural design codes.

In this approach, the structure is analysed by means of several membrane elements in which the concrete and the reinforcement is modelled together as a composite. The Cracked Membrane Model is very accurate for capturing the global behaviour of the structure, but does not yield accurate results in those parts of the structures with static and/or geometric discontinuities (D-regions). The analysis of such details should be analysed with a model in which the reinforcement and the concrete are modelled separately (the Compatible Stress Field Model presented in the previous slide is the state-of-the-art approach for doing this).

An example of application of the CMM-Usermat for a 3D Wall is presented later in this chapter.

# Overview of numerical models for structural design and analysis

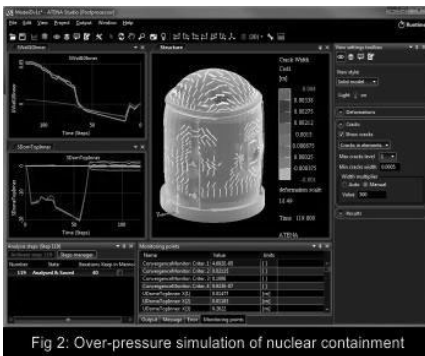

Fig 2: Over-pressure simulation of nuclear containment

[Cervenka, 2020]

## Full non-linear finite element analyses

- Assessment task
  - . Concrete geometry, loads and reinforcement are known
  - . Non-linear finite element analysis (NLFEA)  $\rightarrow \sigma \xleftrightarrow{\varepsilon} \varepsilon$ 
    - Many available models (usually very complex)
    - Tensile strength usually considered for equilibrium
    - Not compliant with structural design codes
- Time devoted to analysis: very high
- Many commercial software available (Ansys, Abaqus, Atena, Dyana...)
- Not a design tool. Rarely used in practice for assessment (skilled users)

constitutive  
relationship

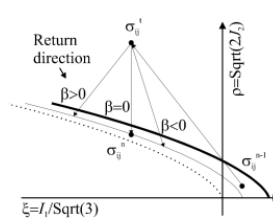

Fig. 2-22 Plastic predictor-corrector algorithm.

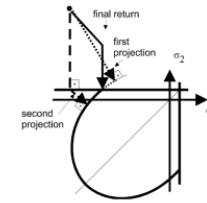

Fig. 2-23. Schematic description of the iterative process (2.73). For clarity shown in two dimensions.

[Cervenka, 2020]

While existing general non-linear FE programs overcome the aforementioned oversimplifications of linear elastic analysis and allow capturing the real structural behaviour provided correct mechanical models and material parameters are defined, these methods are not suitable for design purposes. The complexity of the implemented mechanical methods requires a very high expertise and modelling time, while the results might be very sensitive to the choice of material parameters unknown in the design phase. Furthermore, the mechanical models implemented in non-linear FE-analysis typically are not code-compliant as their hypothesis differ very significantly from those of classic reinforced concrete design (e.g. concrete tensile stresses often contributes to the resistance of the members in NLFEA) and the partial safety factor format cannot be applied. In consequence, non-linear FE-analysis is useful only for research and assessment purposes.

These approaches are hardly ever used in practice, only by very skilled users. Due to the complexity of the models the probability of making a modelling mistake leading to unconservative results is significant.

# Cracked Membrane Model Usermat (CMM-Usermat)

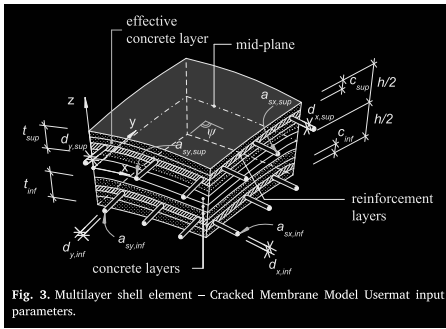
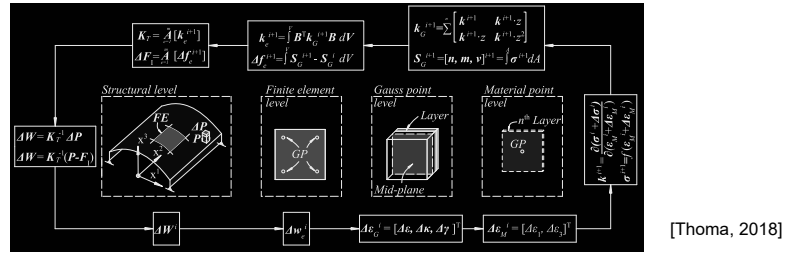

[Thoma, 2018]

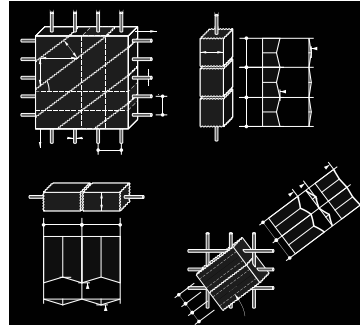

[Kaufmann, 1998]

This corresponds with the Cracked Membrane Model with rotating cracks (CMM-R) already presented in the previous chapter when discussing the Compression Field Approaches. In the numerical implementation a multilayer approach is possible.

## Cracked Membrane Model Usermat (CMM-Usermat)

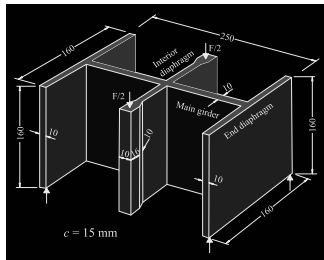

### Comparison between experiment and CMM-Usermat calculation

- Reinforced concrete shear wall: IWT2 (from Leonhardt and Walther)

- . Indirectly supported plate with indirect load introduction

### - Results

- . Measured and calculated load-deformation curves agree well
- . Same failure mechanism at exactly the same location
- . Crack pattern at failure are also sufficiently similar

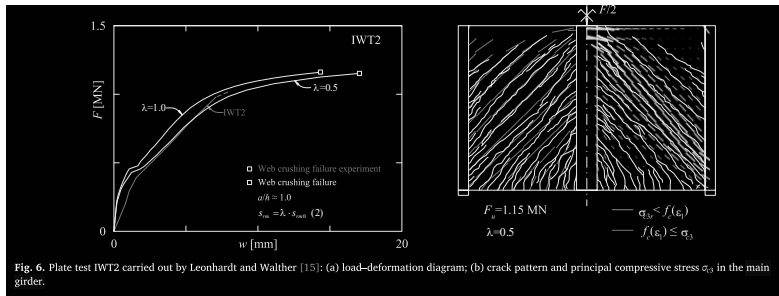

Fig. 6. Plate test IWT2 carried out by Leonhardt and Walther [15]: (a) load-deformation diagram; (b) crack pattern and principal compressive stress  $\sigma_3$  in the main girder.

[Thoma, 2018]

This slide shows the analysis of a three-dimensional system of wall elements with the CMM-Usermat. The multilayer approach allows to capture the behaviour of a system of folded walls with symmetrical loads (as shown in this example) or even non-symmetrical loads that generate transverse actions.

# Compatible Stress Field Method

## Compatible Stress Field Method (CSFM) - Implemented in commercial software IdeaStatiCa Detail

Continuous stress fields = Computer-aided stress fields

### Scope

- Simple method for efficient, code-compliant design and assessment of discontinuity concrete regions
- Including serviceability and deformation capacity verifications
- Direct link to conventional RC design: standard material properties, concrete tensile strength totally neglected for equilibrium (only its influence to the stiffness is accounted for)

### Inspirations

- EPSF FE-implementation (strain compatibility, automatic determination of concrete reduction factor from strain state)
- Tension Chord Model TCM and Cracked Membrane Model CMM (tension stiffening, ductility and serviceability checks)

### Development / Credits

**ETH zürich**

**IDEA StatiCa®**  
Calculate yesterday's estimates



This project has received partial funding from Eurostars-2 joint programme, with co-funding from the European Union Horizon 2020 research and innovation programme

13.10.2021

ETH Zurich | Chair of Concrete Structures and Bridge Design | Advanced Structural Concrete

17

In spite of the evolution of computational tools over the past decades, stress fields and strut-and-tie models essentially keep being used as hand calculations. This makes their application tedious and time-consuming since iterations are required and several load-cases need to be considered in real-life structures. Furthermore, checking concrete dimensions is based on semi-empirical, somewhat arbitrary rules for the effective concrete compressive strength, undermining the mechanical consistency of the methods, and deformation capacity – particularly regarding reinforcement ductility – cannot be verified. In addition, these methods are not suitable for verifying serviceability criteria (deformations, crack widths, etc.).

The stated limitations can be overcome by using Compatible Stress Fields, which consists of a simplified non-linear finite element based continuous stress field analysis that considers compatibility of deformation and automatically computes the effective compressive strength of concrete. In this way, Stress Fields can be automatically generated and serviceability and deformation capacity can be checked as soon as suitable constitutive relationships are considered.

The Compatible Stress Field Method (CSFM) is a software that has been developed in ETH Zurich in collaboration with IDEA StatiCa to make stress fields suitable for engineering. This has been achieved by considering equilibrium at stress-free cracks and implementing simple uniaxial constitutive laws provided in concrete standards for concrete and reinforcement. In this way the analysis can be carried out the concrete and reinforcement grade (i.e. without the need for additional material properties as required for general purpose nonlinear FE-analyses).

# Compatible Stress Field Method

## Dimensioning/assessment of Discontinuity Regions: Previously existing computer-aided tools

CAST (Tjhin & Kutchma, 2002)  
(strut-and-tie →  $f_c$ =? Realistic results?)

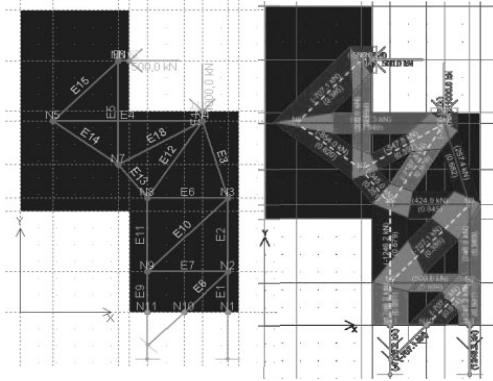

[Mata-Falcón & Sánchez-Sevilla, 2006]

AStrutTie (HanGil)  
(strut-and-tie →  $f_c$ =? Realistic results?)

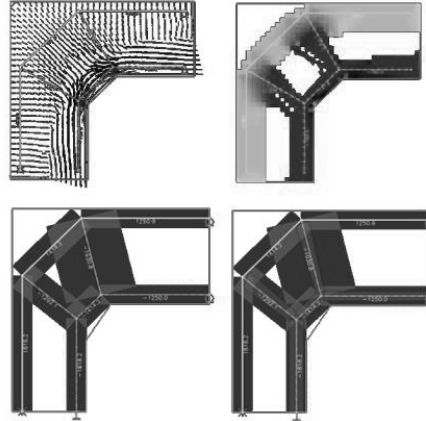

[HanGil, 2017]

Idea StatiCa for specific details  
(corbels, piles caps...)

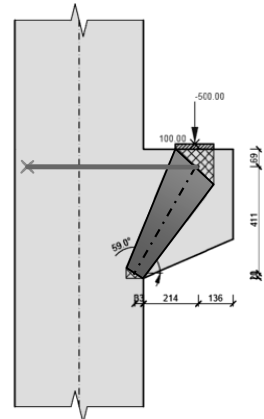

[IDEA, 2017]

Several attempts to develop programs for computer-aided truss modelling were made over the past decades. Many existing applications implementing strut-and-tie models for specific regions, such as e.g. corbels and pile caps, had limited impact due to their limited scope. Only few tools, such as e.g. CAST (Tjhin and Kuchma 2002) and AStrutTie (2017), are more general and allow the design of arbitrary discontinuity regions. Although these applications are very interesting, they did not find widespread application in engineering practice so far, presumably because the user has to come up with an initial strut-and-tie model and assign a “correct” effective concrete compressive strength to each individual truss member or node. In spite of being implemented in a computer program, this process is typically still time-consuming, affecting user friendliness and efficiency, and somewhat arbitrary.

# Compatible Stress Field Method

## Dimensioning/assessment of Discontinuity Regions: Previously existing computer-aided tools

Stringer-Panel Models (Nielsen, 1971; Blauwendraad & Hoogenboom, 1996; Marti & Heinzmann, 2012)

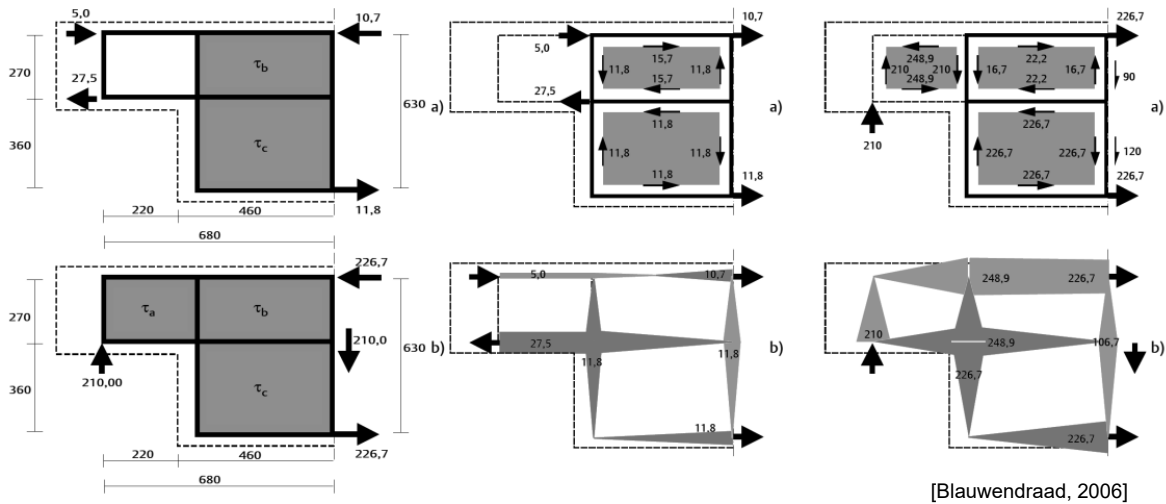

Stringer-Panel models date back to 1929 (Wagner used them for steel panels bounded by flanges). In structural concrete, Nielsen also used stringer-panel models as early as 1971.

Hoogenboom, in his doctoral thesis guided by Prof. Blauwendraad at TU Delft, was the first to implement this type of model into FEM software. It yields good results, as also demonstrated by the work of Daniel Heinzmann under Peter Marti (predecessor of Prof. Kaufmann) at ETH Zurich. The problem of this model when building a general tool is the difficulty to adapt to elements with complex shapes (it is not possible to model diagonal reinforcement e.g. in a dapped end beam).

# Compatible Stress Field Method

## Dimensioning/assessment of Discontinuity Regions: Previously existing computer-aided tools

EPSF elastic plastic stress fields (Fernández Ruiz & Muttoni, 2007)

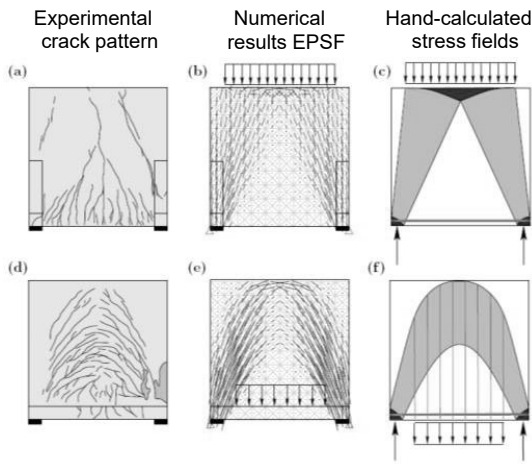

[Muttoni & Fernandez Ruiz, 2007]

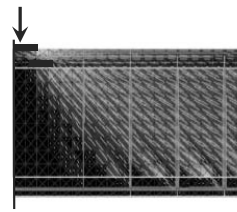

- ⊕ Maintains advantages of hand calculations (transparent, safe design with  $f_{ct} = 0$ , consistent detailing)
- ⊕ Compressive strength  $f_c$  determined automatically from strain state

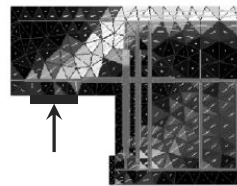

- ⊖ Limited user-friendliness
- ⊖ Limited use for serviceability ... no tension stiffening ... no crack width calculation
- ⊖ No check of deformation capacity (perfectly plastic material)

The lack of generality of the previous approaches are avoided in the elastic-plastic stress field method (EPSF), developed in EPFL by Fernández Ruiz and Prof. Muttoni (2007). Continuous stress fields rather than strut-and-tie models are considered in this approach, in which the effective concrete compressive strength is calculated from the transverse strains as specified by modern design codes, similar as in compression field analyses accounting for compression softening (Vecchio and Collins 1986; Kaufmann and Marti 1998). Basically, this method corresponds to a simplified, nonlinear finite element analysis. Contrary to general nonlinear FE-calculations, however, only standard material parameters known at the design stage are required as input. The EPSF method yields excellent failure load predictions (Muttoni, Ruiz, and Niketic 2015), but its user-friendliness is limited since it was not developed as a commercial program. Moreover, since it neglects tension stiffening, EPSF cannot be directly used for serviceability checks, nor for elements with insufficient deformation capacity.

Note: The program automatically obtains the stiffest load transfer mechanism (= minimisation of complementary strain energy) → Arch mechanism if the load is suspended (suspension reinforcement = soft, should be as short as possible → arch)



# Compatible Stress Field Method

## CSFM: design process

### 1) Definition of geometry, loads and load combinations

- BIM connections: export data from a global model for the analysis of a detail
- Standalone application:

Full definition  
in standalone  
user-friendly  
application

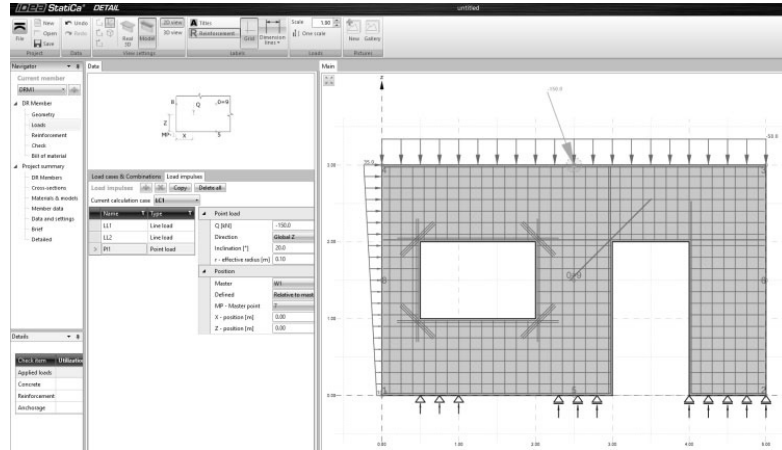

The design process with the Compatible Stress Field Method (CSFM) starts with the definition of the geometry, loads and loads combination. While designers could optimise the geometry during the analysis process, a well-defined should be input in a first place. All this information can be read automatically from a more general model via the BIM connections. Alternatively the software can be also used as a standalone application.

# Compatible Stress Field Method

## CSFM: design process

### 2) Reinforcement design

- a) Location of reinforcement: definition by user. Several design tools are provided to identify where the reinforcement is required (for complex regions):

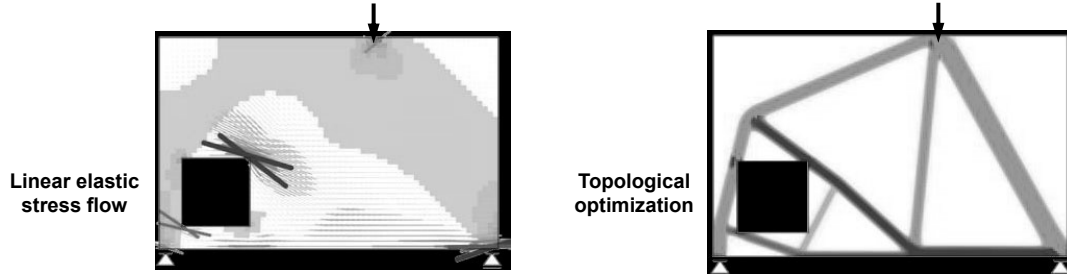

- b) Amount of reinforcement: can be automatically designed for all or part of the reinforcement. Not yet released in current version

### 3) Verification models to check all code requirements

- a) Load-bearing capacity  
b) Serviceability verifications (deformations, crack width...)

For regions where the reinforcement layout is not known beforehand, there are two methods available in the CSFM to help the user determine the optimum location of reinforcing bars: linear analysis and topology optimization. Both tools provide an overview of the location of tensile forces in the uncracked member for a certain load case. While it is considered good practice to place the reinforcement close to the location of linear-elastic tensile forces to reduce the amount of reinforcement and the required plastic redistributions, this is not the case for any structural element. Designers must interpret the results of these design tools and finally provide reinforcement layouts taken into account other constraints (e.g. constructive requirements). For instance, these tools typically provide diagonal tensile forces (e.g. to carry shear loads), while this inclined force might be typically resisted by a truss mechanism with orthogonal reinforcement.

Once the layout of the reinforcing bars has been defined, the required areas should be determined. The reinforcement amount might be already known in many design cases (where the reinforcement amount can be pre-designed e.g. by means of a simplified cross-sectional analysis) as well as in assessment verifications. For other cases, the CSFM implements a tool called 'rebar optimization' that helps the user in the dimensioning of the reinforcement, i.e., determining reinforcement areas in terms of number of bars and their diameters. In this tool the user first defines for which bars the required area should be designed (in case not all the bars are to be optimised). Selected bars can be grouped for the optimization, meaning that the resulting area will be constant for each bar in that group. A simplified version of the verification model presented in point 3 is then used to minimise the overall volume of reinforcement.

After the location and amount of reinforcement is perfectly, the structural element has to be verified using Compatible Stress Fields, as will be shown in the following.

# Compatible Stress Field Method

## CSFM verification model: main assumptions

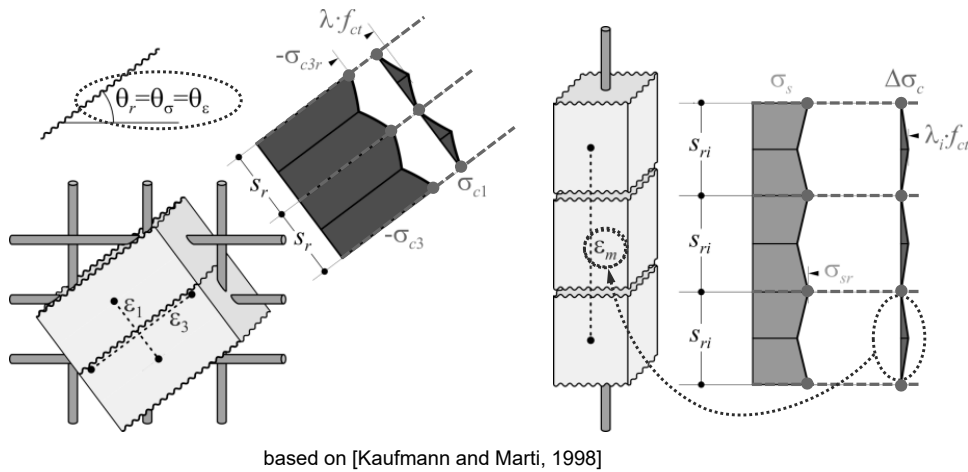

Main assumptions:

- Fictitious rotating-stress-free cracks ( $\sigma_{c1,r}=0$ ) without slip
- Average strains
- Equilibrium at cracks:
  - i. Maximum stresses:  $-\sigma_{c3,r}/\sigma_{s,r}$
  - ii. Concrete tensile strength neglected except for tension-stiffening:  $\epsilon_m$

Suitable for elements with minimum transversal reinforcement. Slender elements without shear reinforcement might lead to unconservative results.

The CSFM assumes fictitious, rotating, stress-free cracks opening without slip, and considers the equilibrium at the cracks together with average strains of the reinforcement. Hence, the model considers maximum concrete ( $\sigma_{c3r}$ ) and reinforcement stresses ( $\sigma_{sr}$ ) at the cracks, while neglects the concrete tensile strength ( $\sigma_{c1r} = 0$ ) except for its stiffening effect on the reinforcement. The consideration of tension stiffening allows capturing the average reinforcement strains ( $\epsilon_m$ ).

According to the assumptions of the model, the principal directions of stresses and strains coincide and the behaviour of the principal directions in the cracked state is decoupled except for the compression softening effect. This justifies the use of the simple uniaxial laws.

In spite of their simplicity, similar assumptions have been demonstrated to yield accurate predictions for reinforced members subjected to in-plane loading (Kaufmann 1998; Kaufmann and Marti 1998) if the provided reinforcement avoids brittle failures at cracking. Furthermore, neglecting any contribution of the tensile strength of the concrete to the ultimate load is consistent with classical design procedures based on plasticity theory and, more importantly, the principles of modern design codes.

It should be noted that the method might lead to unconservative results for slender elements without transverse reinforcement. While some design standards allow designing such elements based on semi-empirical provisions, the CSFM is not intended for this type of potentially brittle structures.

## Compatible Stress Field Method

CSFM verification model: concrete

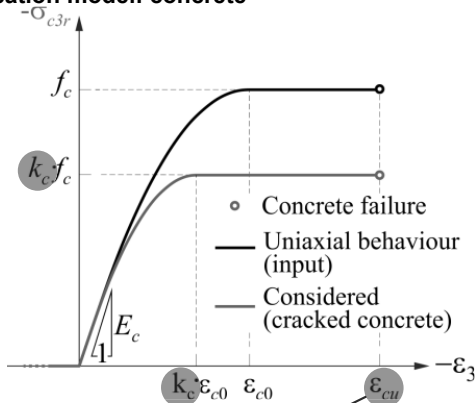

- Strain limitations of concrete specified by codes (explicitly considers the increasing brittleness of concrete with strength).
- Imposed to the average strain over a characteristic crushing band length.

- $k_c$  discrete values for hand calculations

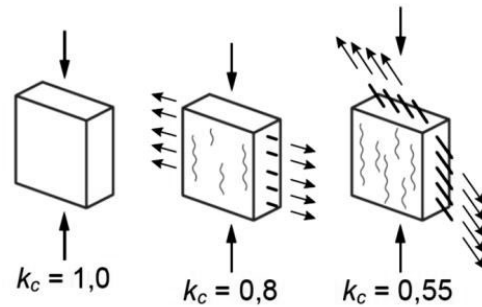

The concrete model implemented in the CSFM is based on the uniaxial compression constitutive laws prescribed by design codes for the design of cross sections, which only depend on the compressive strength. The parabola-rectangle diagram specified EN1992-1-1 is used as a default in the CSFM, but designers can also choose a more simplified elastic ideal plastic relationship. As previously mentioned, the tensile strength is neglected as in classic reinforced concrete design.

The effective compressive strength is automatically evaluated for cracked concrete based on the principal tensile strain ( $\epsilon_1$ ) by means of the  $k_c$  reduction factor. Instead of using discrete values, as provided for hand calculations, more refined continuous relationships are used.

## Compatible Stress Field Method

CSFM verification model: concrete

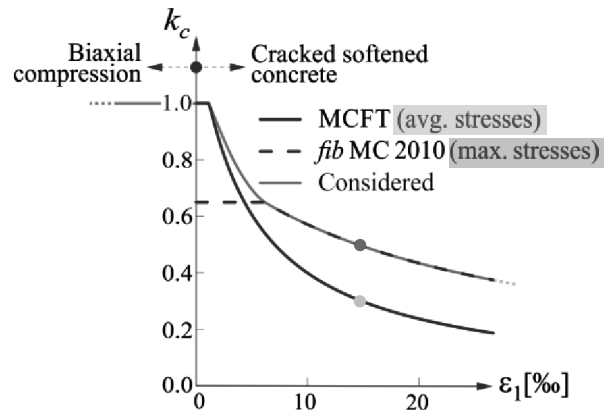
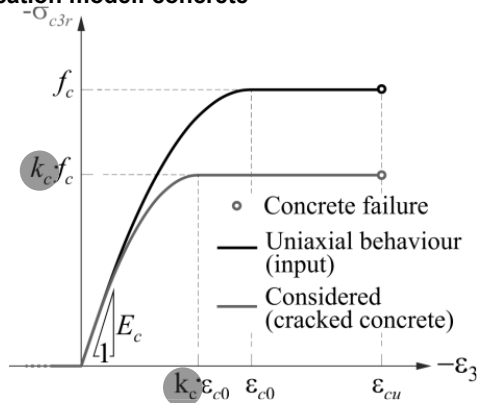

- Strain limitations of concrete specified by codes (explicitly considers the increasing brittleness of concrete with strength).
- Imposed to the average strain over a characteristic crushing band length.
- $k_c$  (compression softening) automatically computed based on the transversal strain state.
- Use of *fib* MC 2010 / SIA 262:213 proposal for shear verifications (consistent with considered max. stresses) extended for general cases.

The reduction relationship implemented used in CSFM is a generalisation of the SIA 262 / *fib* Model Code 2010 proposals for shear verifications, which contains a limiting value of 0.65 for the maximum value of the concrete compressive strength not applicable to other loading cases. This compression softening law is consistent with the main assumptions of CSFM, since it is also derived in terms of maximum stresses at the cracks. Other relationships derived in terms of average stresses (i.e. accounting for a contribution of concrete tensile stresses to the strength), as e.g. in the Modified Compression Field Theory (MCFT) by Vecchio & Collins (1986), may be excessive when applied to models such as CSFM which consider maximum stresses at cracks (i.e. without any contribution of concrete in tension).

# Compatible Stress Field Method

## CSFM verification model: verification of anchorage length and reinforcement

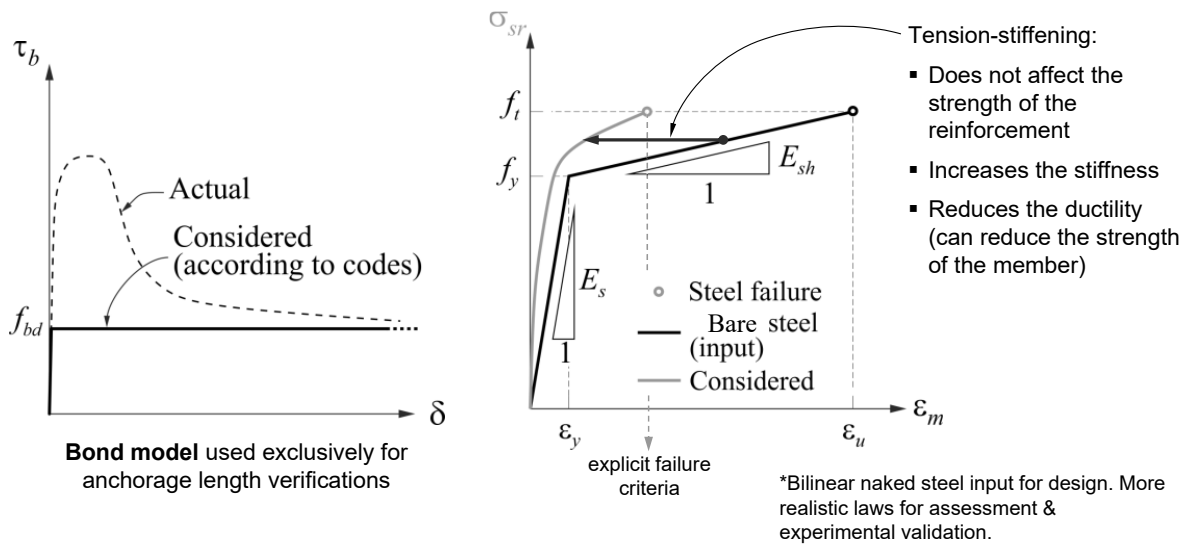

Bond-slip between reinforcement and concrete is introduced in the finite element model for ultimate limit state load cases by considering the simplified rigid-perfectly plastic constitutive relationship presented in the left figure, with  $f_{bd}$  being the design value of the ultimate bond stress specified by the design code for the specific bond conditions. This is a simplified model with the sole purpose of verifying the anchorage length prescriptions according to design codes (i.e. anchorage of reinforcement). The reduction of the anchorage length when using hooks, loops and similar bar shapes can be considered by defining a certain capacity at the end of the reinforcement.

Regarding the reinforcement model, the idealised bilinear stress-strain diagram for the naked reinforcing bars as typically defined by design codes (right figure, bare reinforcement) is considered by default. The definition of this diagram only requires basic properties of the reinforcement known during the design phase (strength and ductility class). Tension stiffening is accounted for by modifying the input stress-strain relationship of the reinforcing bare bar in order to capture the average stiffness of the bars embedded in concrete ( $\epsilon_m$ ). The details of the tension stiffening model are discussed in the following.

# Compatible Stress Field Method

## CSFM verification model: tension stiffening

Stabilized crack pattern

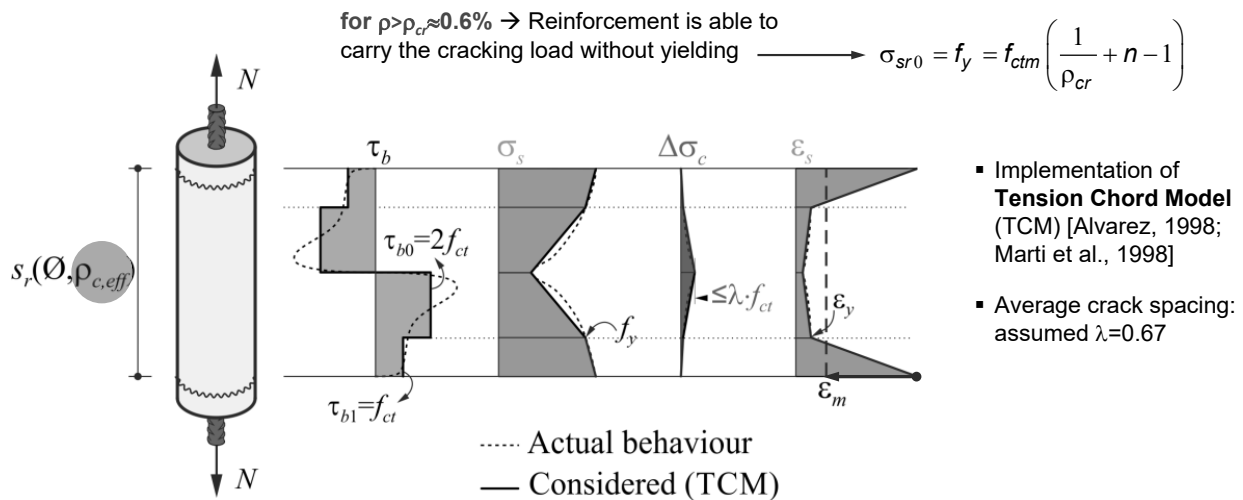

13.10.2021

ETH Zurich | Chair of Concrete Structures and Bridge Design | Advanced Structural Concrete

27

In fully developed crack patterns, tension stiffening is introduced using the Tension Chord Model (TCM) (Marti et al. 1998; Alvarez 1998) which has been shown to yield excellent response predictions in spite of its simplicity. The TCM assumes a stepped, rigid-perfectly plastic bond shear stress-slip relationship with  $\tau_b = \tau_{b0} = 2 f_{ctm}$  for  $\sigma_s \leq f_y$  and  $\tau_b = \tau_{b1} = f_{ctm}$  for  $\sigma_s > f_y$ . Treating every reinforcing bar as a tension chord, the distribution of bond shear, steel and concrete stresses and hence the strain distribution between two cracks can be determined for any given value of the maximum steel stresses (or strains) at the cracks. The crack spacing may vary by a factor of two, i.e.  $s_r = \lambda s_{r0}$ , with  $\lambda = 0.5 \dots 1.0$ . The Idea StatiCa Detail implementation of the CSFM considers by default an average crack spacing ( $\lambda = 0.67$ ) when performing the stress field analysis. However, in order to obtain conservative values, the crack width checks derived from this analysis will consider a maximum crack spacing ( $\lambda = 1.0$ ), as will be seen in later slides.

For more details about the TCM see Stahlbeton I, online APP or next chapter about deformation capacity of beams.

The application of the TCM depends on the reinforcement ratio and hence, assigning an appropriate concrete area acting in tension between the cracks to each reinforcing bar is crucial. To this end, an automatic procedure to define the corresponding effective reinforcement ratio ( $\rho_{eff}$ ) for any configuration has been developed (see details in slide 18).

# Compatible Stress Field Method

## CSFM verification model: tension stiffening

Non-stabilized crack pattern

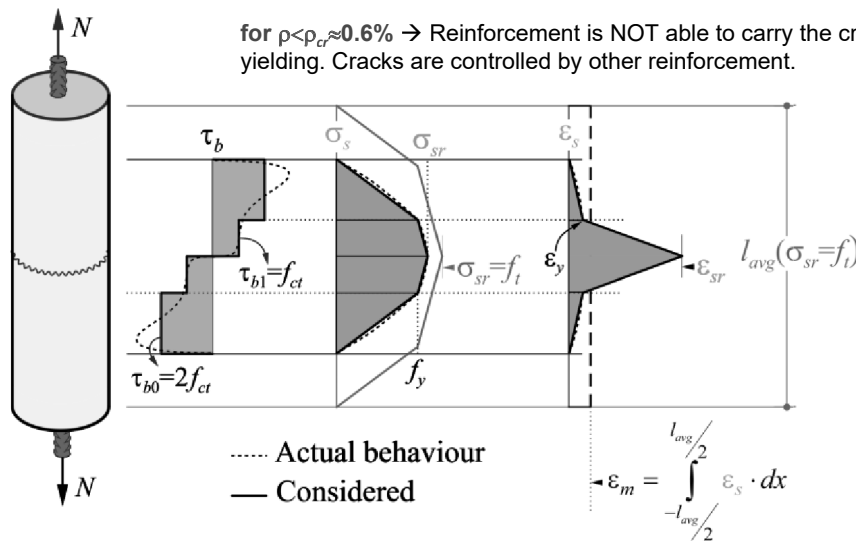

- Independent cracks are assumed + bond model of Tension Chord Model.
- Crack localization (size effect): stiffness of the whole rebar embedded in concrete > local stiffness near the crack (considered average strain over  $l_{avg}$ ).

Cracks existing in regions with geometric reinforcement ratios lower than  $\rho_{cr}$ , i.e. the minimum reinforcement amount for which the reinforcement is able to carry the cracking load without yielding, are generated by either non-mechanical actions (e.g. shrinkage) or progression of cracks controlled by other reinforcement. In such cases tension stiffening is implemented by means of the Pull-Out Model (POM) described in the figure. This model analyses the behaviour of a single crack by (i) considering no mechanical interaction between separate cracks, (ii) neglecting the deformability of concrete in tension and (iii) assuming the same stepped, rigid-perfectly plastic bond shear stress-slip relationship used by the TCM. Given the fact that the crack spacing is unknown for a non-fully developed crack pattern, the average strain ( $\epsilon_m$ ) is computed for any load level over the distance between points with zero slip when the reinforcing bar reaches its tensile strength ( $f_t$ ) at the crack ( $l_{\epsilon,avg}$  in the figure)



## Compatible Stress Field Method

### CSFM verification model: tension stiffening

Resultant tension chord behaviour

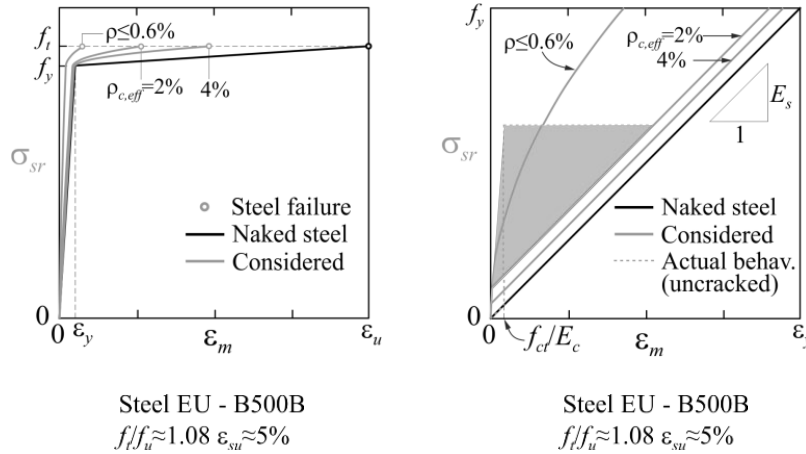

- Fully cracked behaviour considered for design.
- Uncracked initial stiffness can be considered for refined verification models.

The proposed models allow computing the behaviour of bonded reinforcement, which is finally considered in the analysis. The behaviour including tension stiffening for the most common European reinforcing steel (B500B, with  $f_t / f_y = 1.08$  and  $\epsilon_u = 5\%$ ) is illustrated in the figures. It can be observed that the consideration of tension stiffening does not affect the strength of the reinforcement, but increases its stiffness and significantly reduces its ductility. Still, tension stiffening might indirectly affect the ultimate loads in certain cases, either negatively or positively: (i) The reduction of the ductility of the reinforcement may limit the strength of members with low amounts of transverse reinforcement, and (ii) the higher stiffness due to tension stiffening results in lower transverse tensile strains imposed to the concrete in compression and hence, a less pronounced reduction of the concrete compressive strength and correspondingly higher ultimate loads in members where concrete crushing is governing.

## Compatible Stress Field Method

### CSFM verification model: effective area of concrete in tension

→ suitable for numerical implementation and valid for automatic definition of  $\rho_{c,eff}$  in any region

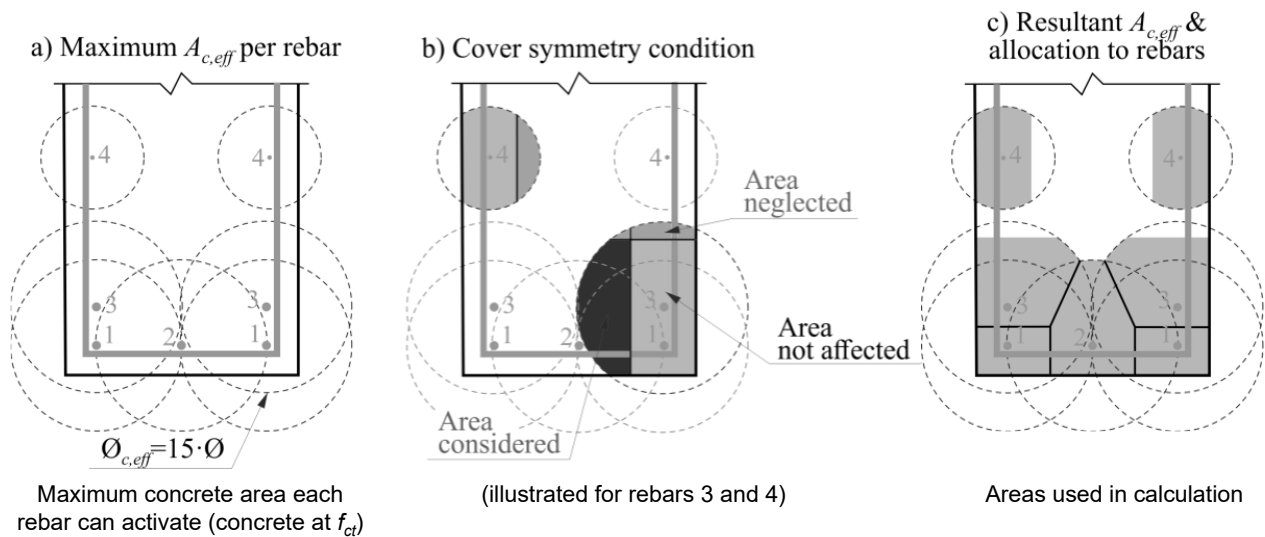

As already introduced, the TCM requires knowing the effective reinforcement ratio of each rebar ( $\rho_{eff}$ ). A procedure suitable for automatic calculation has been developed. The concept is presented in the figure and consists of the following steps: (i) definition of the maximum area of concrete that each reinforcing bar can activate in tension when activated to  $f_t$  (left figure), (ii) verification of the symmetry condition of the tensile concrete stresses caused by each reinforcing bar considering the interaction with adjacent bars (center figure), (iii) assign the effective concrete area to each reinforcing bar based on steps (i) and (ii).

## Compatible Stress Field Method

CSFM verification model: crack width – stabilized crack pattern

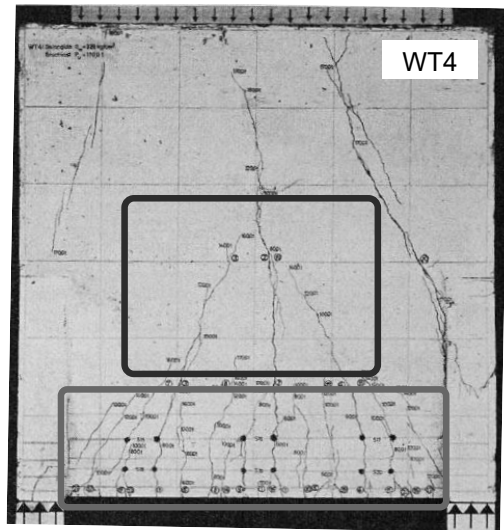
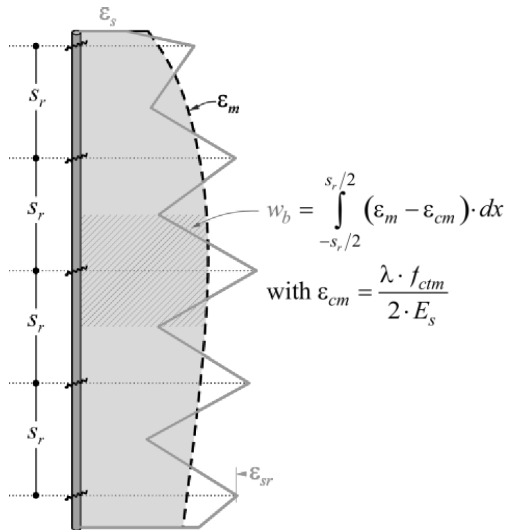

[Walther, 1967]

While CSFM yields a direct result of most verifications (e.g. member capacity, deflections...), the results of crack widths are calculated from the results of reinforcement strains directly provided by the FE-analysis. In a first step, the projection of the crack width in the direction of the rebar ( $w_b$ ) is calculated by integrating the reinforcement strains.

Note that the effect of tension stiffening was included in the average strains ( $\epsilon_m$ ), which were calculated considering an average crack spacing ( $\lambda = 0.67$ ) accounting for an average effect of tension stiffening on all results. For the specific case of crack widths, in order to obtain safe values for the maximum crack widths, a value of  $\lambda = 1.0$  (maximum theoretical crack spacing) is used (crack spacings  $s_r$  are calculated using  $\lambda = 1.0$ ). Moreover, the reinforcement strains obtained from the calculation (using  $\lambda = 0.67$ ) are multiplied by a factor of  $1.0/0.67 = 1.5$  in order to account in a simplified way for the strains associated to maximum crack spacing.

# Compatible Stress Field Method

CSFM verification model: crack width – non-stabilized crack pattern

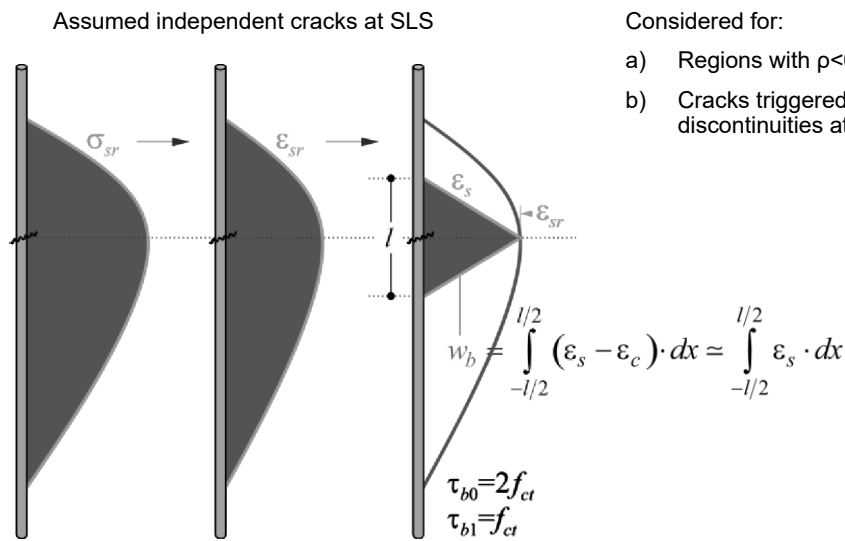

Considered for:

- a) Regions with  $\rho < 0.6\%$
- b) Cracks triggered by geometric discontinuities at low loads

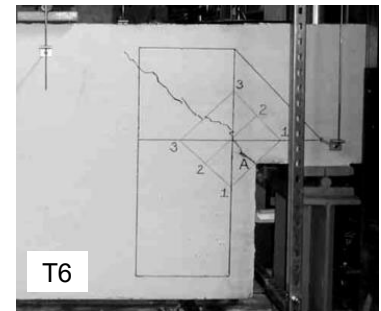
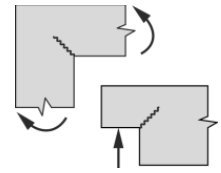

[Zhu et al., 2003]

For the case of tension stiffening assuming non-stabilised cracking, the crack width  $w_b$  is calculated according to the procedure described in the figure, i.e. based on the results of maximum stresses in the reinforcement ( $\sigma_{SR}$ ), which in this case are more reliable than the average strains. From the results of maximum reinforcement stresses, the maximum strains are then computed (bare reinforcement constitutive relationship). Then, for each point, the corresponding strain distributions along the rebar (assuming the simplified bond-slip relationships of the tension chord model) can be calculated. In the last step, the integration of the of the calculated strains along the rebar leads to  $w_b$ .

# Compatible Stress Field Method

## CSFM verification model: crack width – crack kinematic

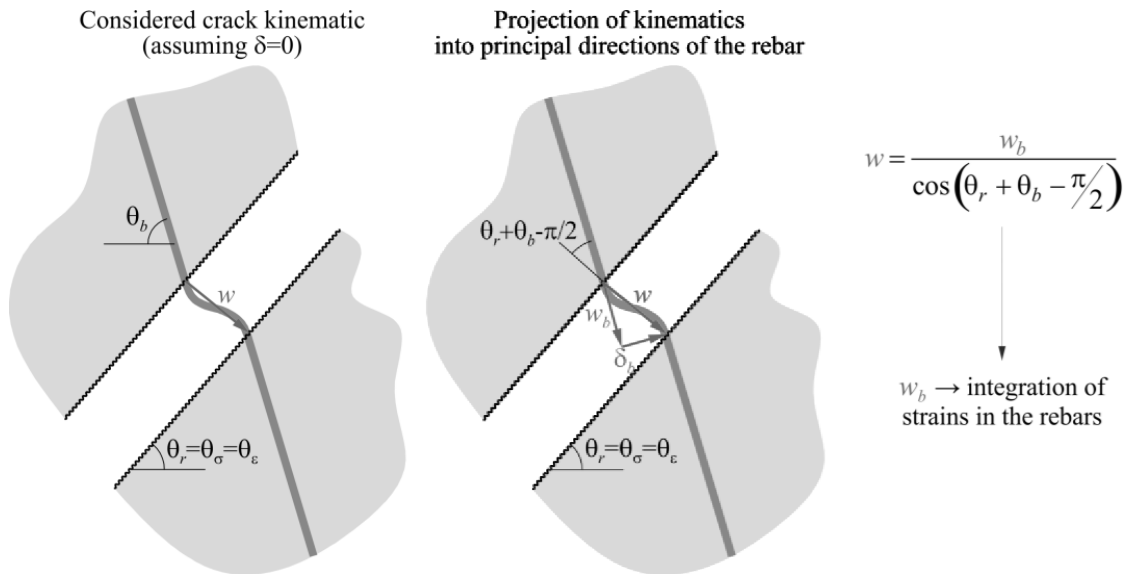

The crack kinematics assuming zero slip allows deriving geometric relationships relating the projection of the crack opening in the direction of the rebar ( $w_b$ ), which was calculated following the procedure given in the previous slides, and the crack width.

# Compatible Stress Field Method

## CSFM & IdeaStatiCa Detail implementation: additional information

Theoretical description of CSFM method & experimental validation

- “Computer-aided stress field analysis of discontinuity concrete regions”, J. Mata-Falcón, D. T. Tran, W. Kaufmann, J. Navrátil; Proceedings of the Conference on Computational Modelling of Concrete and Concrete Structures (EURO-C 2018), 641-650, London: CRC Press, 2018.  
[https://www.researchgate.net/profile/Jaime\\_Mata-Falcon/publication/328419485\\_Computer-aided\\_stress\\_field\\_analysis\\_of\\_discontinuity\\_concrete\\_regions/links/5bcd7f4da6fdcc03c79ad556/Computer-aided-stress-field-analysis-of-discontinuity-concrete-regions.pdf](https://www.researchgate.net/profile/Jaime_Mata-Falcon/publication/328419485_Computer-aided_stress_field_analysis_of_discontinuity_concrete_regions/links/5bcd7f4da6fdcc03c79ad556/Computer-aided-stress-field-analysis-of-discontinuity-concrete-regions.pdf)
- “Compatible Stress Field Design of Structural Concrete: Principles and Validation”, W. Kaufmann, J. Mata-Falcón, M. Weber, D. T. Tran, J. Kabelac, M. Konecny; ISBN 978-3-906916-95-8, ETH Zurich & IDEA StatiCa, 2020. (see additional literature)

Use and installation of Idea StatiCa Detail software:

- Installation of the software: <https://www.ideastatica.com/downloads/>  
Free educational license might be ordered in <https://www.ideastatica.com/educational-license/>
- Idea StatiCa Resource Center (tutorials, sample projects...): <https://www.ideastatica.com/support-center>
- Practical workshop will be organised for those students interested

This slides shows different resources about theoretical information about CSFM as well as practical information about how to install the software (free full educational licenses with 12 months validity are available).

# Compatible Stress Field Method

## CSFM: practical examples in Idea StatiCa Detail

Deep beam with distributed top load

Problem definition

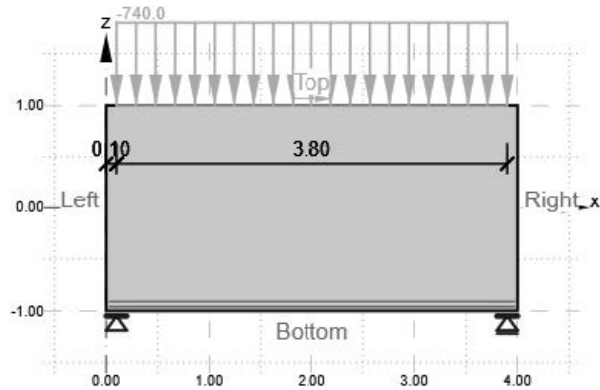

Design of reinforcement

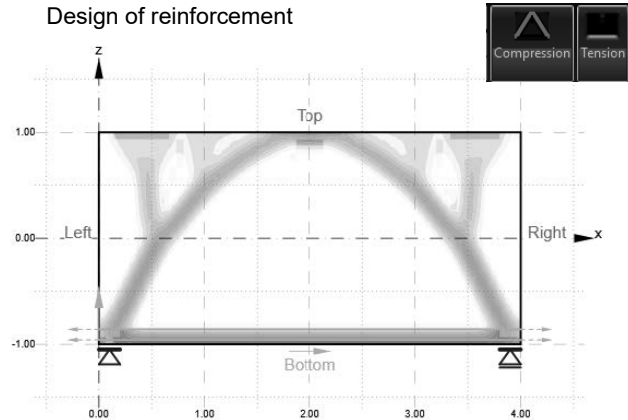

The following slides show an example of application of CSFM by means of the software Idea StatiCa Detail. The example consists of a deep beam with distributed load applied on top of the beam. The right figure shows the results of the reinforcement location design tool (topology optimization). The results show the necessity to place main bending reinforcement (blue = tension), which is something expected without the necessity to recur to this tool. The topology optimization is more powerful for those more complex structures in which the location of reinforcement is not clear beforehand.

# Compatible Stress Field Method

## CSFM: practical examples in Idea StatiCa Detail

Deep beam with distributed top load

Compatible stress fields

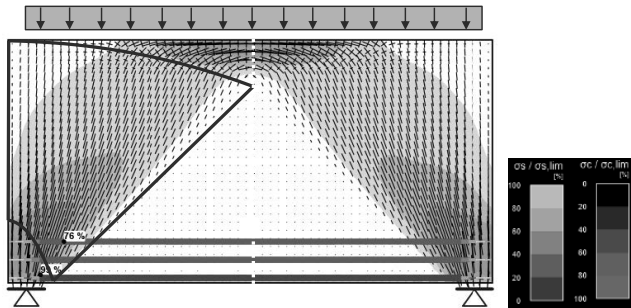

Discontinuous stress fields

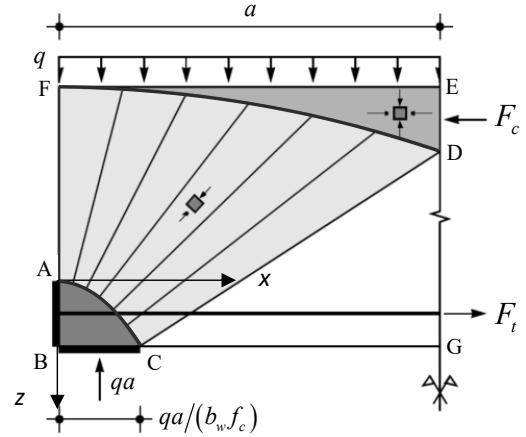

On the left figure the results of Compatible Stress Fields are shown. It can be seen that the results are very similar to the fan mechanism presented in last chapter using classical (discontinuous) stress fields (see right figure). Biaxially loaded nodal regions are generated over the support as well as in the upper part of the beam (consistently with the results of discontinuous stress fields).



# Compatible Stress Field Method

## CSFM: practical examples in Idea StatiCa Detail

Deep beam with distributed load

Top load: fan mechanism

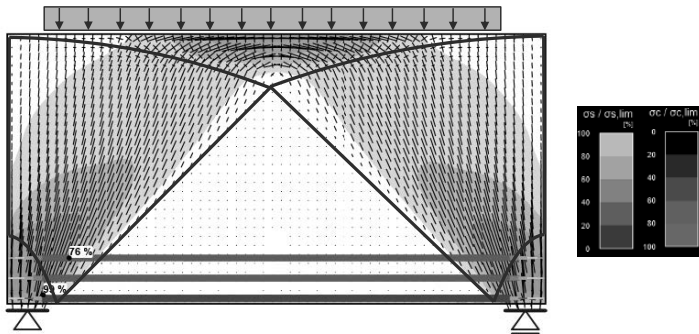

Suspended load: arch mechanism

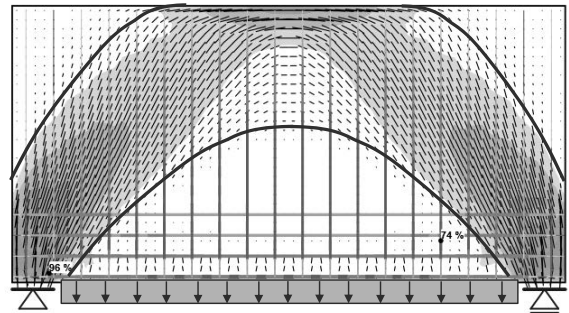

Arch mechanism requires enough capacity of flexural reinforcement; otherwise, the load is suspended until top & fan action is generated

CSFM automatically considers the stiffest mechanism. For the case of load applied on top of the beam this corresponds with a fan mechanism directly to the support. If the load is suspended (right figure), stirrups should be provided to suspend the load. The stiffest mechanism for the suspended load is an arch (see right figure, the load does not have to travel all the way until the upper edge of the beam). However, this mechanism requires a larger horizontal capacity of the nodal zone over the support. If the horizontal capacity of the nodal zone is not large enough, a fan mechanism will be generated even if the load has to be suspended all the way until the top of the beam.

# Compatible Stress Field Method

## CSFM experimental validation

- Direct tension experiments – Alvarez and Marti (1996)
  - Ultimate limit state
  - Load deformation behaviour
  - Crack width
- Pure bending experiments – Frantz and Breen (1978)
  - Crack width distribution
- Cantilever shear walls – Bimschas, Hannewald and Dazio (2010, 2013)
  - Load deformation behaviour under combined loading
  - Bearing capacity under combined loading
- Beams with low amount of transversal reinforcement – Huber, Huber and Kolleger (2016)
  - Bearing capacity in shear (failures due to insufficient ductility of the transversal reinforcement)

In the following slides the results of the CSFM are compared to the experimental results of four different campaigns. Each experiment allows a different validation. The key aspects of this validation are to analyse the capability of CSFM to:

- Predict properly serviceability results (crack widths and deflections).
- Provide a good estimation of the deformation capacity.
- Capture failures due to insufficient ductility of the transversal reinforcement.

# Compatible Stress Field Method

## CSFM experimental validation

Alvarez and Marti (1996) - experimental setup/specimens

Specimen	Z1	Z2	Z4	Z8
Long. reinforcement	14xØ14 ( $\rho = 1\%$ )	14xØ14 ( $\rho = 1\%$ )	14xØ14 ( $\rho = 1\%$ )	10xØ14 ( $\rho = 0.7\%$ )
Steel quality (ductility class)	High	High	Normal	High
$f_{ck\_cube}$ (MPa)	50	90	50	50

Loading: pure tension

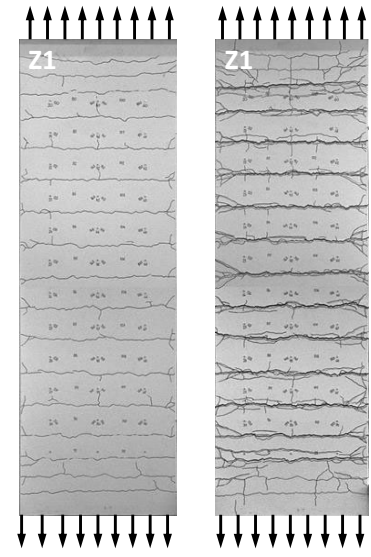

[Alvarez and Marti, 1996]

The first experimental campaign (Alvarez & Marti, 1996) consists of a series of experiments under direct tension. The objective of these tests is to observe, among other aspects, the influence of the amount of reinforcement, the ductility of the reinforcement and the concrete strength in the deformation capacity. The experiments Z1, Z2, Z4 and Z8 are modelled in CSFM and compared to the experimental results.

## Compatible Stress Field Method

### CSFM experimental validation

Alvarez and Marti (1996) - ultimate state

Specimen	Z1	Z2	Z4	Z8
<b>Experiment</b>				
$V_{exp}$ (kN)	1294	1295	1275	924
$\epsilon_{m,exp}$ (%)	6.7	6.8	0.6	6.4
<b>CSFM</b>				
$V_{calc}$ (kN)	1275	1282	1242	918
$\epsilon_{m,calc}$ (%)	7.0	4.6	0.4	6.5
<b>Safety factor</b>				
Strength: $V_{exp}/V_{calc}$	<b>1.01</b>	<b>1.01</b>	<b>1.03</b>	<b>1.01</b>
Deform. capacity: $\epsilon_{m,exp}/\epsilon_{m,calc}$	<b>0.96</b>	<b>1.48</b>	<b>1.50</b>	<b>0.98</b>

$V$ : Peak load

$\epsilon_m$ : Average tensile strain

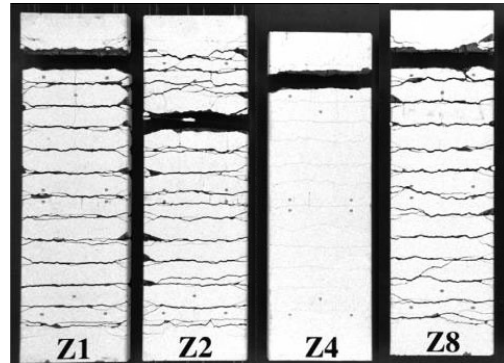

[Alvarez and Marti, 1996]

Here the main results at ULS (load-bearing and deformation capacity) are shown. It can be seen that the strength can be perfectly captured in CSFM. This is not surprising as the strength of the members is equal to the sum of the strength of the longitudinal reinforcement inside. What is more interesting is the comparison of the deformation capacity. CSFM provides a good order of magnitude of the deformation capacity, providing in general estimations of the average strains of the member on the safe side.

## Compatible Stress Field Method

### CSFM experimental validation

Alvarez and Marti (1996)

Load deformation behaviour

— Experimental data  
 - - - CSFM: no tension stiffening  
 - - - CSFM  
 — CSFM: refined

Neglecting tension-stiffening overestimates the deformation capacity up to 5 times (depending on  $\rho$ , the ductility of the reinforcement...)

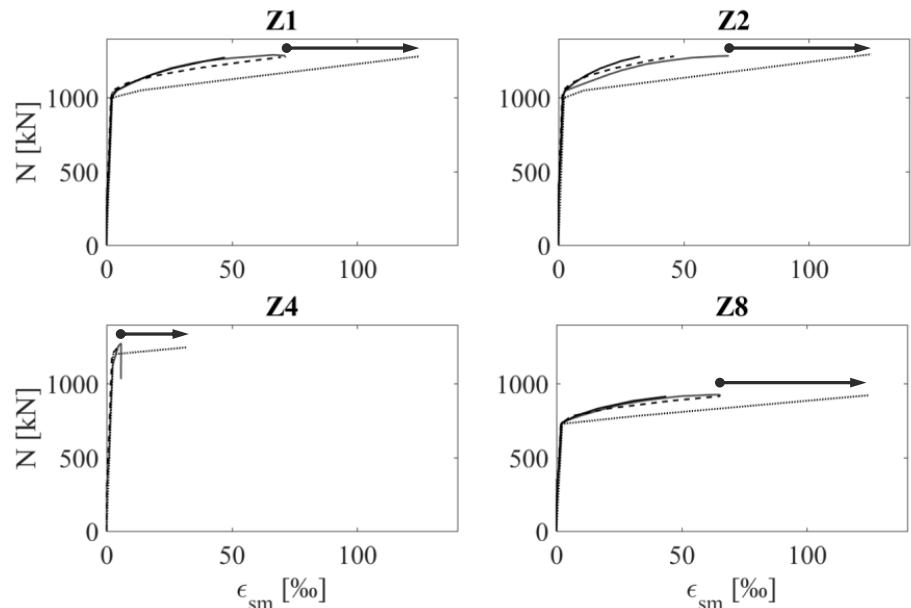

Here to complete load-deformation behaviour is compared. Three different CSFM models are compared: (i) without tension stiffening, i.e. this corresponds to the behaviour of the bare steel; (ii) default CSFM model, i.e. assuming bilinear idealization of the bare reinforcement; and (iii) refined model, considering the experimental stress-strain relationships. It can be seen that the model neglecting tension stiffening overestimates very significantly the deformation capacity of the members (up to 5 times). The other two CSFM models considering tension stiffening provide a good estimation of the deformation capacity, in general on the safe side.

## Compatible Stress Field Method

### CSFM experimental validation

Alvarez and Marti (1996) -  
crack width

- +— Experiment - average
- Experiment - max
- - - CSFM - max ( $\lambda=1.0$ )
- CSFM - ( $\lambda=0.67$ )
- · - · - CSFM - min ( $\lambda=0.5$ )

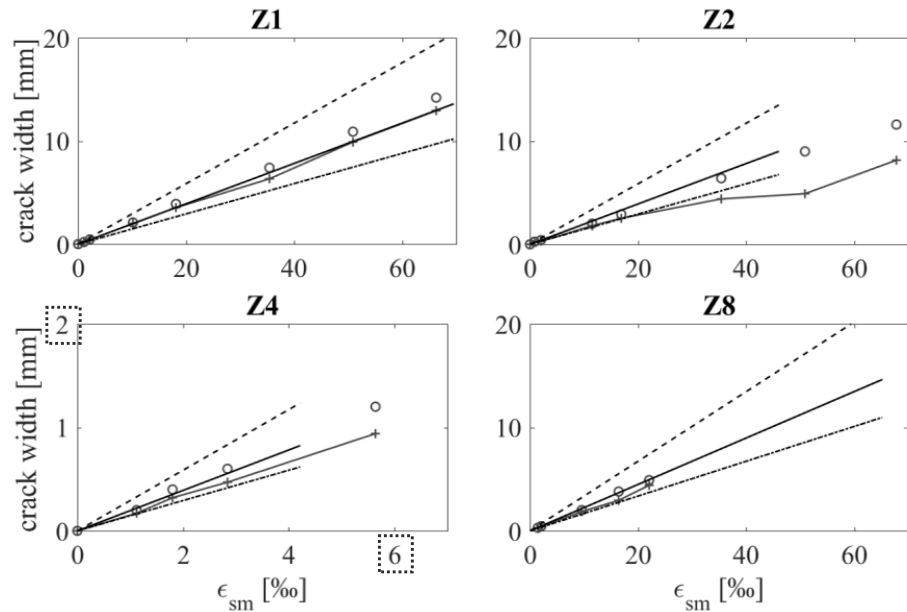

As it can be seen from the results in the figure the crack width can also be predicted very accurately. The experimental results of mean and maximum crack widths lie in between the predictions of the model considering minimum and maximum crack widths.

# Computergestützte Spannungsfelder

## CSFM experimental validation

Frantz and Breen (1980) - experimental setup/specimen

Specimen	RS-3
Main reinforcement	2x $\varnothing$ 15.88 6x $\varnothing$ 12.7
Web reinforcement	6x $\varnothing$ 6

Loading: pure bending

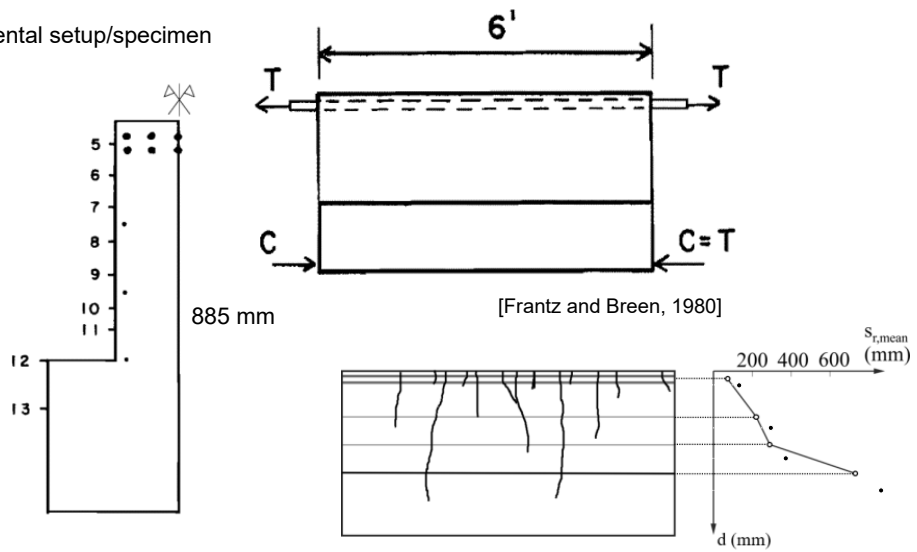

This second example deals with a pure bending test of a T-beam with almost 900 mm depth. The beam contains a large amount of bending reinforcement and a minimum amount of longitudinal reinforcement in the web of the beam. Consequently, the crack spacing is not constant in the web of the beam (see bottom right figure). The crack spacing is smaller in the main tension chord (higher amount of reinforcement leads to smaller crack spacing, see theory of Tension Chord Model), while it increases within the web (lower amount of reinforcement).

## Compatible Stress Field Method

### CSFM experimental validation

Frantz and Breen (1980) – crack width

- +— Experiment - average
- CSFM - max ( $\lambda=1.0$ )
- CSFM - ( $\lambda=0.67$ )
- CSFM - min ( $\lambda=0.5$ )

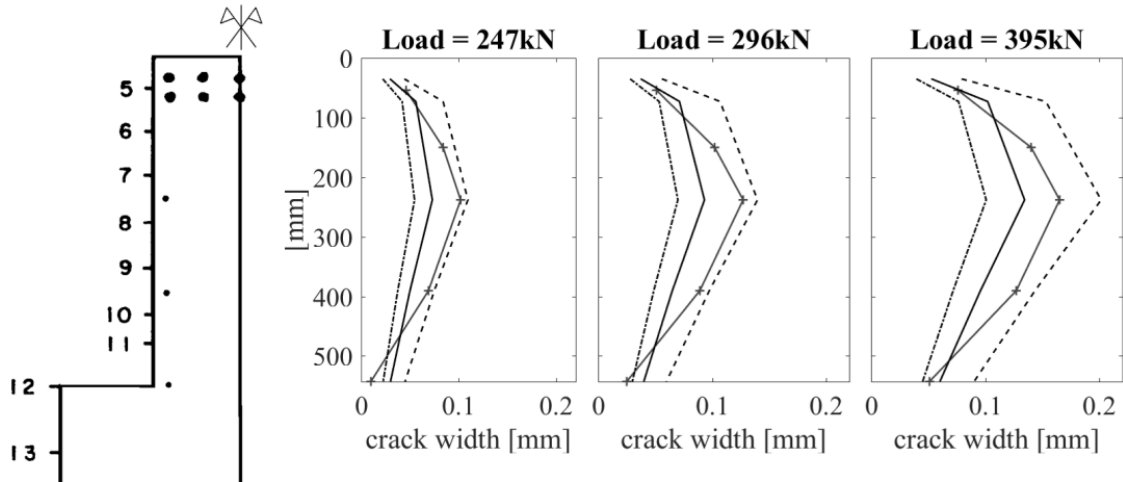

The crack width results show that the crack width is not maximum at the upper edge (=main tension chord), what might be expected if a constant crack spacing is assumed in the beam, as the strains are larger in the upper edge. The largest crack widths produce in the middle of the web, where the crack spacing is large and the reinforcement strains are close to the maximum (crack width is a product of the crack spacing and the average strains). This effect can be simulated quite well with CSFM (see white plots in the figure for average, mean and maximum crack spacing) as it considers the variation of both strains and crack spacing within the web of the beam.



# Compatible Stress Field Method

## CSFM experimental validation

Bimschas et al. (2010, 2013) – experimental setup/specimens

Specimen	VK1	VK3	VK6
Effective height (m)	3.30	3.30	4.50
Section depth (m)	1.50	1.50	1.50
Section width (m)	0.35	0.35	0.35
$\rho_{sl}$ (%)	0.82	1.23	1.23
$\rho_{st}$ (%)	0.08	0.08	0.08

→  $\epsilon_U = 8.4\%$

**Loading:** constant normal force  $N = -1370\text{kN}$ ; quasi-static cyclic loading with increasing amplitudes in horizontal direction.

**Note:** CSFM aim at describing the backbone of the cyclic response using a monotonic model. Strain penetration into the foundation is not considered.

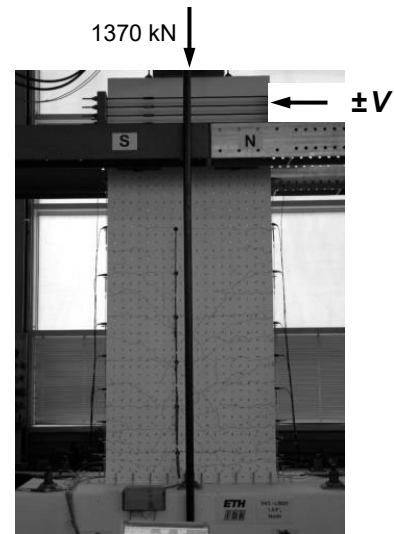

VK1: first yielding of reinforcement

[Bimschas, 2010]

In this third example, Bimschas (2010) and Hannewald et al. (2013) studied the force-deformation response of cantilever wall-type bridge piers under quasi static-cyclic loading. The figure shows the experimental setup, leading to a combined axial, bending and shear loading. Bimschas et al. (2015) showed that the cyclic envelope of these experiments can be reasonably approximated using a monotonic analysis as CSFM. In this context, the experimental envelope of the cyclic response is re-evaluated for three specimens (VK1, VK3 and VK6) and compared with the CSFM results. The displacement component is obtained by subtracting the part due to anchorage slip from the total measured displacement at height of load application since the foundation is not modelled in CSFM. The contribution of anchorage slip is estimated following the assumptions given in Bimschas et al. (2015). The table summarises the parameters relevant for the analysis in which  $\rho_{sl}$  and  $\rho_{st}$  indicate the geometric amount of reinforcement of the longitudinal and the transversal reinforcement respectively. The three analysed specimens differ in the amount of longitudinal reinforcement and the effective depth. It should be noted that the transversal reinforcement consisted of high ductility reinforcement (therefore, no rupture of the stirrups was produced during the tests).

## Compatible Stress Field Method

### CSFM experimental validation

Bimschas et al. (2010, 2013) – peak load

Specimen	VK1	VK3	VK6
<b>Experiment*</b> $V_{exp}$ (kN)	728	876	647
<b>CSFM</b> $V_{calc}$ (kN)	730	860	650
$V_{exp}/V_{calc}$	<b>1.00</b>	<b>1.02</b>	<b>1.00</b>

\*mean peak horizontal load of North and South directions.

Note: CSFM aims at describing the behaviour of the backbone until concrete peak horizontal strength is reached, ( $\neq$  to loss of vertical bearing capacity).



VK1: peak strength

VK1: failure

[Bimschas, 2010]

CSFM cannot capture the post-peak behaviour. Therefore, CSFM only aims at describing the behaviour of the backbone until the concrete crushing is reached (what does not correspond with the loss of the vertical capacity).

The table shows the comparison of the experimental and the predicted peak load-bearing capacity. The agreement is also perfect. However, this is not surprising. Given the fact that the stirrups do not fail because of insufficient capacity, the shear walls fail in a conventional bending failure. Therefore, the ultimate capacity could be predicted as well very accurately with a conventional plastic cross-sectional analysis. What CSFM offers in addition for this case is the estimation of the load-deformation behavior (see following slide).

# Compatible Stress Field Method

— Experi  
 .....CSFM:  
 ---CSFM  
 —CSFM:

## CSFM experimental validation

Bimschas et al. (2010, 2013) – load deformation behaviour

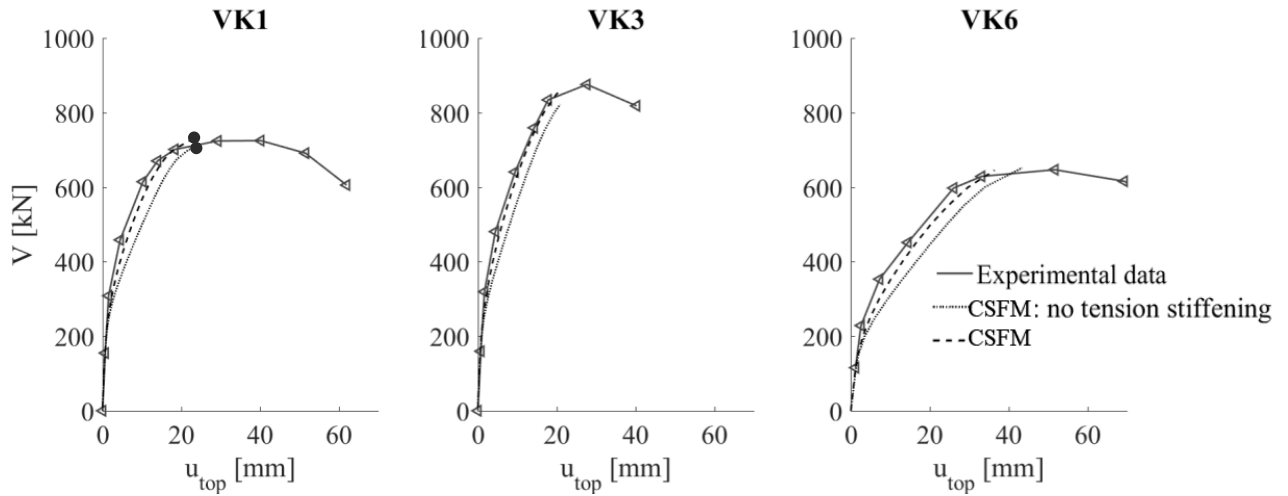

- Failure mode: concrete crushing in compression. Failure is considered when the strain limit criteria specified in codes for sectional analysis is reached on average over the crushing band length.

The experimental results are compared to a default CSFM model, as well as to a CSFM analysis in which tension stiffening is neglected. As tensile strength is neglected for equilibrium, the onset of decompression is underestimated in CSFM. When neglecting tension-stiffening the deflections are overestimated significantly.

# Compatible Stress Field Method

## CSFM experimental validation

Bimschas et al. (2010, 2013) – stress fields specimen VK1

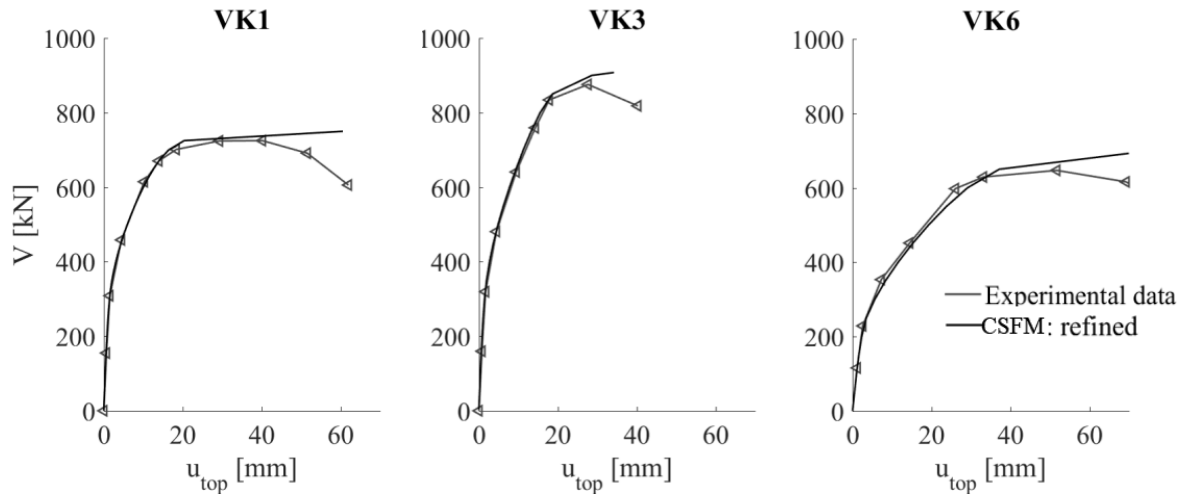

Note: Refined analysis considers the initial uncracked stiffness, as well as the actual stress-strain relationship of the reinforcement. Moreover, no concrete strain limitation is considered.

The CSFM can be refined by (i) consider in the analysis the initial uncracked stiffness and by (ii) considering the actual stress-strain relationship of the reinforcement. By considering these two aspects an almost perfect matching of the experimental load-deformation behaviour with CSFM is reached.

## Compatible Stress Field Method

CSFM experimental validation: Bimschas et al. (2010, 2013) – load deformation behaviour

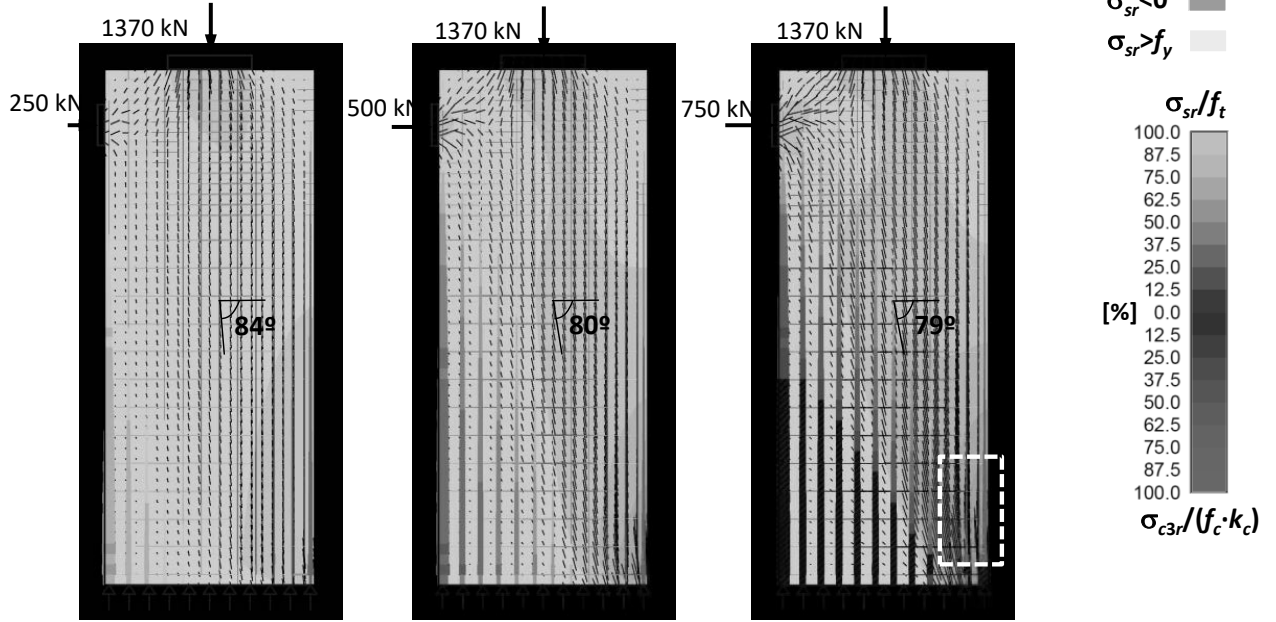

13.10.2021

ETH Zurich | Chair of Concrete Structures and Bridge Design | Advanced Structural Concrete

49

These graphs show for VK3 the results of stress fields for three different levels of the horizontal load.

# Compatible Stress Field Method

## CSFM experimental validation

Huber et al. (2016) – experimental setup/specimens

Specimen	R1000m35	R1000m60	R500m352	R500m351
Section depth	1.00 m	1.00 m	0.50 m	0.50 m
Section width	0.30 m	0.30 m	0.15 m	0.15 m
$\rho_w$	0.094 %	0.094 %	0.084 %	0.094 %
$\varnothing_w$	Ø6	Ø12	Ø4	Ø6
$f_c$	29.6 MPa	60.9 MPa	35.9 MPa	37.9 MPa

$\varnothing_w$ (mm)	$f_y$ (MPa)	$f_t$ (MPa)	$\epsilon_u$ (%)
4	653	710	4.9
6	569	658	3.1
12	552	654	3.4

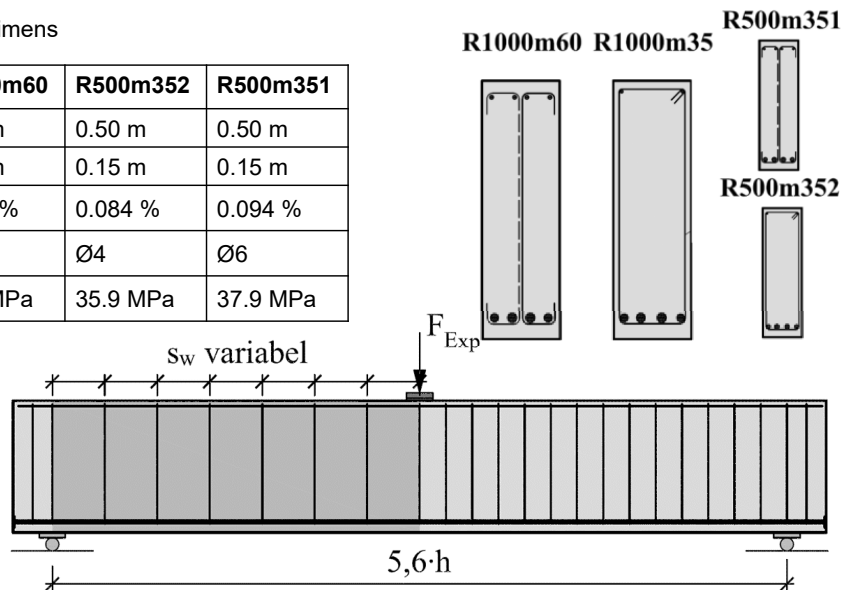

Huber et al. (2016) tested simply supported beams with and without a minimum amount of transverse reinforcement according to the experimental setup shown in the figure. In this context, four experiments of this campaign with transverse reinforcement and failing by rupture of this transverse reinforcement are analysed in this section. The tables summarize the parameters relevant for the analysis.

The objective of this validation is to see if a classical stress field model (considering ideal plastic behavior of the reinforcement, i.e. infinite ductility) is able to capture properly the behavior or rather the CSFM (with a proper estimation of the reinforcement ductility) leads to a more satisfactory result.

# Compatible Stress Field Method

## CSFM experimental validation

Huber et al. (2016) – ultimate load

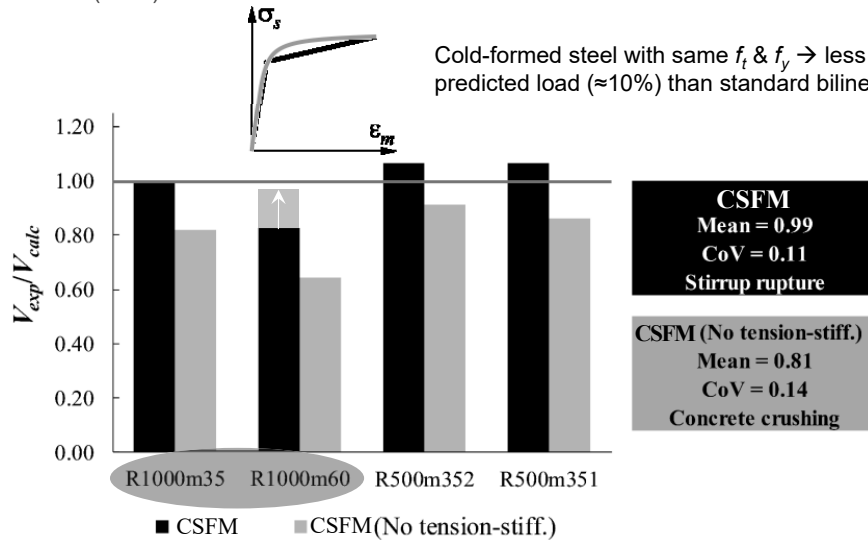

- Neglecting tension stiffening leads to unsafe load predictions and does not capture the real failure mode (stirrup rupture).
- Higher impact of strain localization in real size elements → use of existing experimental databases could underestimate the impact of these failures.

This slide shows the predictions of a conventional CSFM model (in white) and a CSFM model without tension-stiffening, i.e. assuming infinite ductility of the stirrups, as assumed in a classical rigid-plastic stress field analysis. In the graph the ratio between the experimental and the predicted ultimate load is shown ( $V_{exp}/V_{calc} < 1$  means unconservative estimation of the ultimate load). It can be seen that classical stress fields (without a direct verification of the deformation capacity of the stirrups) overestimate on average a 20% the load-bearing capacity of the beams. In order to reliably estimate the load-bearing capacity of such members, tension-stiffening should be considered.

# Compatible Stress Field Method

## CSFM experimental validation

Huber et al. (2016) – stress fields specimen R1000m35

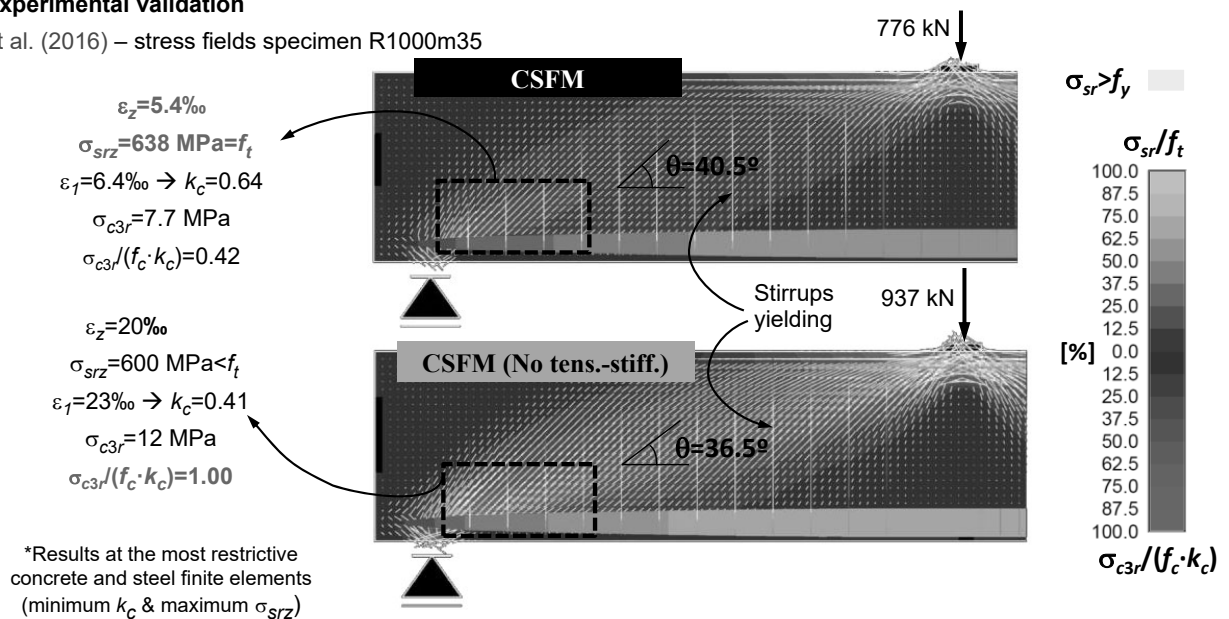

13.10.2021

ETH Zurich | Chair of Concrete Structures and Bridge Design | Advanced Structural Concrete

52

In this slide the results of R1000m35 are compared for both numerical models (with and without tension-stiffening). It can be seen that the predicted failure mode is totally different. In the lower case (without tension-stiffening), the failure of the reinforcement cannot be captured. Therefore, the compression field can further rotate in comparison to the upper solution, i.e. the shear load can be increased for the same capacity of the shear reinforcement. The ultimate load in this case is a 21% higher than when modelling including tension-stiffening. The numerical solutions in this case stops when concrete crushing of the web is detected (what does not match with the observed experimental failure mode in the experiments). In the upper case (with tension-stiffening), the failure of the reinforcement is reliably predicted. As a conclusion, CSFM can predict properly the strength and the deformation capacity of elements with insufficient ductility of the transverse reinforcement.