

# 2 In-plane loading – membrane elements

## 2.4 Equilibrium and yield conditions

This chapter discusses equilibrium and yield conditions for membrane elements.

In the first part, as a repetition of Stahlbeton I, the equilibrium conditions are established and the yield conditions for orthogonally reinforced membrane elements are derived.

In addition, the yield conditions for skew reinforcement are shown.

As in the lecture Stahlbeton I, membrane elements are considered in the plane  $(x, z)$ , since this corresponds to the situation of the girder of a web (longitudinal axis of the girder in  $x$ -direction). Therefore, stresses  $\{\sigma_x, \sigma_z, \tau_{xz}\}$  or membrane forces  $\{n_x, n_z, n_{xz}\} = h \cdot \{\sigma_x, \sigma_z, \tau_{xz}\}$  are investigated ( $h$  = membrane element thickness). Of course, the equilibrium and transformation formulas can be formulated analogously for membrane elements in the plane  $(x, y)$  (stresses  $\{\sigma_x, \sigma_y, \tau_{xy}\}$  and membrane forces  $\{n_x, n_y, n_{xy}\} = h \cdot \{\sigma_x, \sigma_y, \tau_{xy}\}$ ).

## Learning objectives

Within this chapter, the students are able to:

- identify the relevance of membrane elements in structural concrete, and how they can be used to design a more general shell structure.
- assess the equilibrium of reinforced concrete membrane elements as a combination of concrete and reinforcement.
  - combine the yield conditions of concrete and reinforcement to determine the yield conditions of membrane elements with orthogonal reinforcement.
  - distinguish and explain the different yield regimens.
  - design membrane elements with orthogonal reinforcement either with yielding of both reinforcements (regime 1) or with concrete crushing and yielding of the longitudinal reinforcement (regime 2).
  - illustrate the behaviour of a membrane element with skew reinforcement and yielding of both reinforcements (regime 1) by means of Mohr's circles.

## Membrane elements - Introduction

### Definition

The analysis of membrane elements presented in this chapter is valid for:

- In-plane loaded elements
- Homogeneously loaded (i.e. no variations of stresses)
- Homogeneously distributed reinforcing bars → steel and bond stresses can be modeled by equivalent stresses uniformly distributed over the thickness and in the transverse direction between the reinforcing bars

Only a very few structural elements fulfil these criteria and can be directly designed as a single membrane element. Why studying this theoretical case?

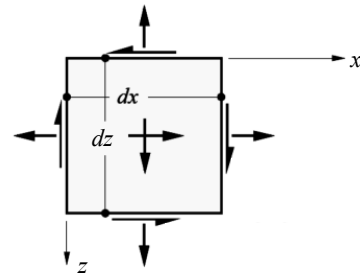

Membrane elements are strong simplifications from reality. Many structural elements are not only subjected to in-plane loading, as e.g. slabs or shells subjected to general loading. Moreover, even in in-plane loading structures, the reinforcement and the applied loading are hardly ever evenly distributed in the entire structural element. Why is this case very relevant?

# Membrane elements - Introduction

## Modelling of structures composed by plane elements

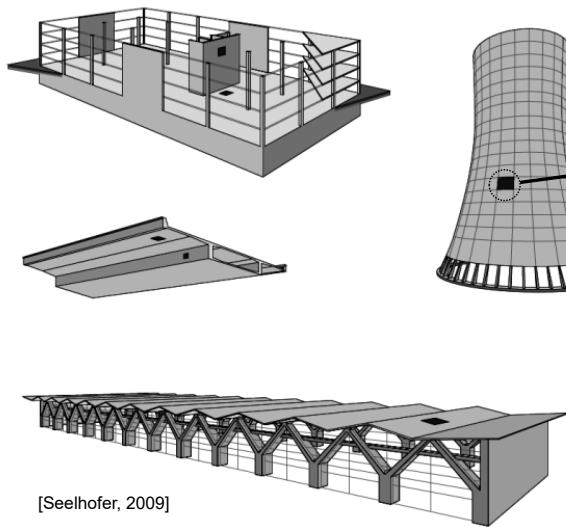

## Generally loaded shell element (8 stress resultants)

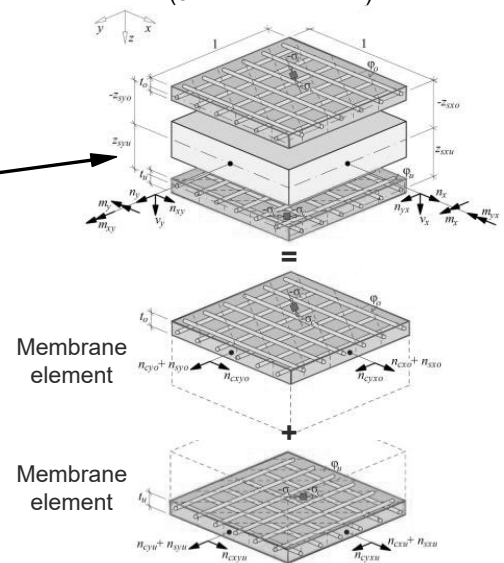

Most concrete structures can be modelled as a superposition of local plane elements. A plane elements subjected to general loading can be modelled by a combination of membrane elements. This general loading can be modelled as sublayers subjected to in-plane loads (membrane elements).

In the right figure the sandwich model is shown. This model will be presented in the chapter of slabs. The sandwich covers carry the bending and twisting moments with in-plane loads, besides the membrane forces. Hence, each cover is subjected exclusively to in-plane loading and can be treated and design as a membrane element. In addition, the sandwich core absorbs the transvers shear forces. The principal shear direction of the core can be also design as a membrane element (similarly to the web of a beam). In the case of high membrane (compressive) forces the core can also be used to resist the membrane forces, however, the interaction with the transverse shear force should be considered. This can be done by discretising the structural element with multiple coupled membrane layers. This is known as a layered approach.

These approaches are typically applied by means of numerical approaches (further information in specific chapter on this topic).

# Membrane elements - Equilibrium

## Equilibrium conditions

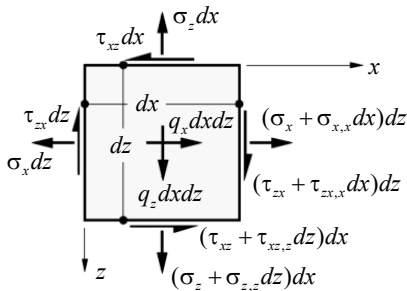

A stress component is taken as positive if it acts in a positive (negative) direction on an element face where a vector normal to the face is in a positive (negative) direction relative to the axis considered.  
 Positive membrane forces correspond to positive stresses  
 Indices: 1-direction of the stress, 2-direction of the normal vector

Equilibrium in directions x, z:

$$\frac{\partial \sigma_x}{\partial x} + \frac{\partial \tau_{xz}}{\partial z} + q_x = 0$$

$$\frac{\partial \tau_{zx}}{\partial x} + \frac{\partial \sigma_z}{\partial z} + q_z = 0$$

Or in membrane forces  
 ( $\sigma, \tau$  constant over membrane element thickness  $h$ ):

$$\frac{\partial n_x}{\partial x} + \frac{\partial n_{xz}}{\partial z} + h \cdot q_x = 0$$

$$\frac{\partial n_{zx}}{\partial x} + \frac{\partial n_z}{\partial z} + h \cdot q_z = 0$$

$$(n_x = h\sigma_x \quad n_z = h\sigma_z \quad n_{xz} = h\tau_{xz})$$

With (moment condition  $M_y = 0$ ):

$$\tau_{zx} = \tau_{xz} \quad \text{resp.} \quad n_{zx} = n_{xz}$$

## Repetition Stahlbeton I:

- Equilibrium conditions for membrane elements
- Formulation in stresses  $\{\sigma\}$  or in membrane forces  $\{n\}$  with  $\{n\} = h \cdot \{\sigma\}$  (with the membrane element thickness  $h$  (often also defined as  $t$  or  $b_w$ ))

## Membrane elements - Stress transformation

### Stress transformation: Mohr's circle

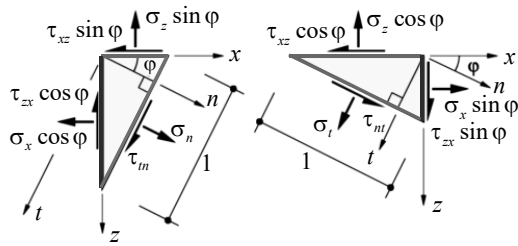

$$\begin{aligned}\sigma_n &= \sigma_x \cos^2 \varphi + \sigma_z \sin^2 \varphi + 2\tau_{xz} \sin \varphi \cos \varphi \\ \sigma_t &= \sigma_x \sin^2 \varphi + \sigma_z \cos^2 \varphi - 2\tau_{xz} \sin \varphi \cos \varphi \\ \tau_{nt} &= (\sigma_z - \sigma_x) \sin \varphi \cos \varphi + \tau_{xz} (\cos^2 \varphi - \sin^2 \varphi)\end{aligned}$$

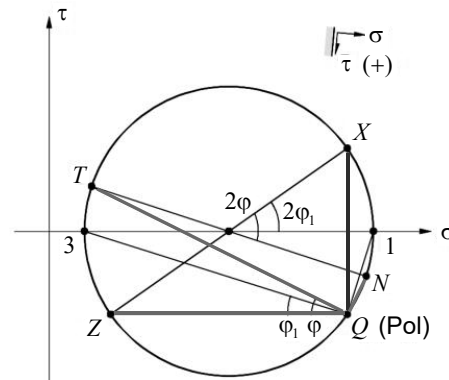

### Repetition Stahlbeton I:

- Stress transformation and representation in the Mohr's Circle
- Principal directions and principal stresses (directions with  $\tau_{tn} = 0$ , maximum / minimum values of normal stress)
- The sign convention in Mohr's circle differs from the usual convention

# Membrane elements - Stress transformation

## Stress transformation: Mohr's circle

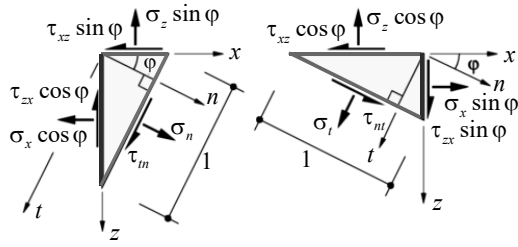

$$\sigma_n = \frac{\sigma_x + \sigma_z}{2} + \frac{\sigma_x - \sigma_z}{2} \cos 2\varphi + \tau_{xz} \sin 2\varphi$$

$$\sigma_t = \frac{\sigma_x + \sigma_z}{2} + \frac{\sigma_x - \sigma_z}{2} \cos 2\varphi - \tau_{xz} \sin 2\varphi$$

$$\tau_{nt} = -\frac{\sigma_x - \sigma_z}{2} \sin 2\varphi + \tau_{xz} \cos 2\varphi$$

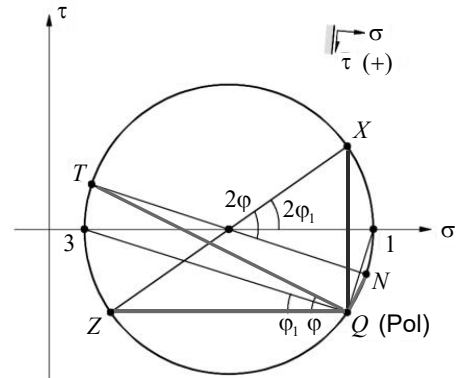

$\cos 2\varphi = \cos^2 \varphi - \sin^2 \varphi$ $1 = \sin^2 \varphi + \cos^2 \varphi$ $\sin 2\varphi = 2 \sin \varphi \cos \varphi$
---

# Membrane elements - Stress transformation

## Stress transformation: Mohr's circle

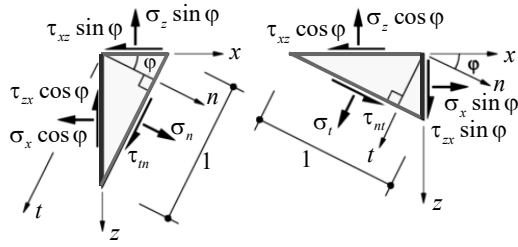

$$\sigma_n = \frac{\sigma_x + \sigma_z}{2} + \frac{\sigma_x - \sigma_z}{2} \cos 2\varphi + \tau_{xz} \sin 2\varphi$$

$$\sigma_t = \frac{\sigma_x + \sigma_z}{2} + \frac{\sigma_x - \sigma_z}{2} \cos 2\varphi - \tau_{xz} \sin 2\varphi$$

$$\tau_m = -\frac{\sigma_x - \sigma_z}{2} \sin 2\varphi + \tau_{xz} \cos 2\varphi$$

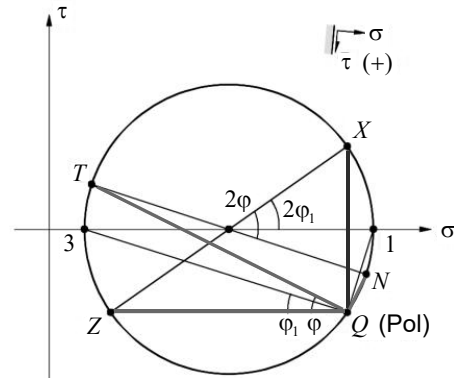

$$\tau_{m1} = \tau_m = 0 \rightarrow \varphi_1 = \frac{1}{2} \tan^{-1} \left( \frac{2\tau_{xz}}{\sigma_x - \sigma_z} \right)$$

$$\sigma_{1,3} = \underbrace{\frac{\sigma_x + \sigma_z}{2}}_{\text{Centre}} \pm \underbrace{\frac{\sqrt{(\sigma_x - \sigma_z)^2 + 4\tau_{xz}^2}}{2}}_{\text{Radius Mohr's circle}}$$



## Membrane elements - Equilibrium

### Equilibrium («reinforced concrete = concrete + reinforcement»)

Orthogonally reinforced element (reinforcement directions  $x, z$ ):

- Concrete is homogeneous and isotropic, absorbs compressive stresses  $\leq f_c$  in any direction but no tensile stresses
- Reinforcement only carries forces in the direction of the bar, up to a maximum value  $f_s$  and is distributed and anchored in such a way that equivalent distributed stresses can be expected
- Perfect bond between concrete and reinforcement

In membrane forces:

$$\begin{aligned} n_x &= n_{xc} + n_{xs} &= n_{xc} + a_{sx} \sigma_{sx} \\ n_z &= n_{zc} + n_{zs} &= n_{zc} + a_{sz} \sigma_{sz} \\ n_{xz} &= n_{xzc} + n_{xzs} &= n_{xzc} \\ (n_x = h\sigma_x \quad n_z = h\sigma_z \quad n_{xz} = h\tau_{xz}) \end{aligned}$$

In equivalent stresses:

$$\begin{aligned} \sigma_x &= \sigma_{xc} + \rho_x \sigma_{sx} \\ \sigma_z &= \sigma_{zc} + \rho_z \sigma_{sz} \\ \tau_{xz} &= \tau_{xzc} \end{aligned}$$

(reinforcement ratios  $\rho_x = a_{sx}/h$ ,  $\rho_z = a_{sz}/h$ )

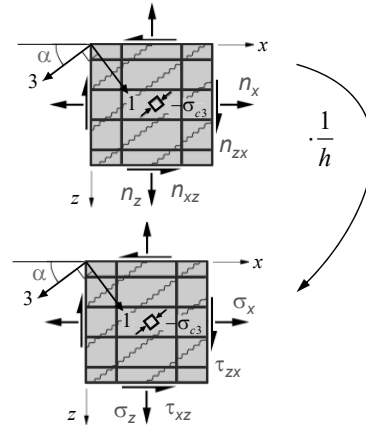

### Repetition Stahlbeton I: Forces in orthogonally reinforced membrane elements

- The applied load must correspond to the sum of the forces in concrete and reinforcement.
- Coordinate axes in reinforced concrete are conventionally selected such that they coincide with the reinforcement directions (usually  $x$ -axis in the direction of the stronger reinforcement). With inclined reinforcement, the  $x$ -axis coincides with one reinforcement direction.
- Orthogonal reinforcement in direction of coordinate axes  $x$  and  $z$  does not contribute to  $n_{xz}$ , i.e.  $n_{xzs} = 0$ .
- Instead of forces, the formulation can be expressed in equivalent stresses (concrete stresses and stresses in the reinforcement multiplied by the respective geometrical reinforcement ratio, which corresponds to the membrane forces divided by the element thickness).

#### Additional remark:

- When strictly deriving equivalent stresses, a correction term should also be introduced for concrete stresses (analogous to the factor  $(1-\rho)$  for normal force), since not the entire membrane element thickness is available. For normal membrane forces in the  $x$ - and  $z$ -directions, this would be  $(1-\rho_x)$  and  $(1-\rho_z)$ . Since usually an inclined stress field results in relation to the reinforcement directions (concrete compression can be transferred as transverse compression via reinforcement), this correction term is usually neglected. However, it can be seen that the concrete stress field is disturbed by the reinforcement.

# Membrane elements - Equilibrium

## Equilibrium («reinforced concrete = concrete + reinforcement»)

Orthogonally reinforced element (reinforcement directions  $x, z$ ):

Representation with Mohr's circles (straightforward for orthogonal reinforcement, since  $\tau_{xzs} = 0$ ):

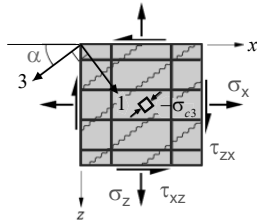

$$\begin{aligned} \sigma_x &= \sigma_{xc} + \rho_x \sigma_{sx} &= \sigma_{c3} \cos^2 \alpha + \rho_x \sigma_{sx} \\ \sigma_z &= \sigma_{zc} + \rho_z \sigma_{sz} &= \sigma_{c3} \sin^2 \alpha + \rho_z \sigma_{sz} \\ \tau_{xz} &= \tau_{zxc} &= -\sigma_{c3} \sin \alpha \cos \alpha \end{aligned}$$

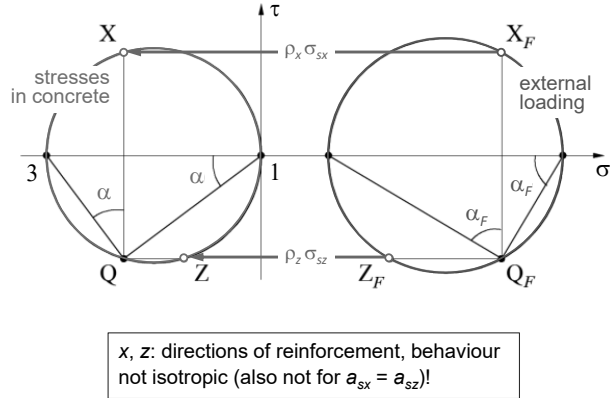

$x, z$ : directions of reinforcement, behaviour not isotropic (also not for  $a_{sx} = a_{sz}$ )!

$\alpha$ : Principal direction of concrete compression

## Repetition Stahlbeton I: Forces in orthogonally reinforced membrane elements

- Behaviour is not isotropic, not even with "isotropic reinforcement" (same reinforcement in both directions)!
- «Shear» is related to the direction of the ( $x$ -) reinforcement!

## Membrane elements - Yield conditions

### Yield conditions of Tresca and v. Mises for plane stress conditions

(not suitable for reinforced concrete, not even for "isotropic reinforcement"!)

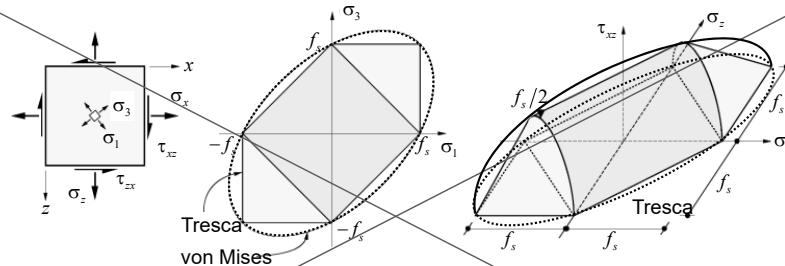

Tresca

$$\text{Max}(|\sigma_1|, |\sigma_3|, |\sigma_1 - \sigma_3|) - f_s = 0$$

- Principal stress plane: hexagon
- Space: two elliptical cones and connecting elliptical cylinder

v. Mises

$$\sigma_x^2 - \sigma_x \sigma_z + \sigma_z^2 + 3\tau_{xz}^2 - f_s^2 = 0$$

- Principal stress plane: ellipse circumscribed by the Tresca hexagon
- Space: Ellipsoid circumscribed by the yield condition of Tresca

Yield conditions for isotropic materials (e.g. steel: Tresca, von Mises) cannot be applied to reinforced concrete, neither for the dimensioning of reinforcement and not even if it is "isotropic" (equal reinforcement ratio in both directions). Their application can be on the safe or unsafe side.

There is an obvious difference, for example, for the behaviour under combined tensile/compressive actions, where loading in one reinforcement direction does not influence the resistance of the reinforcement in the other reinforcement direction; according to Tresca / von Mises, on the other hand, compressive resistance in one direction is reduced by tensile loading acting perpendicularly to it (and vice versa). On the other hand, a material with yield conditions according to Tresca / von Mises has a shear resistance, which orthogonal (isotropic) reinforcement does not have.

## Repetition SBI - Interaction diagrams (M, N)

Rectangular cross-section - rigid-perfectly plastic behaviour, without concrete cover

(1) Concrete

Repetition SBI

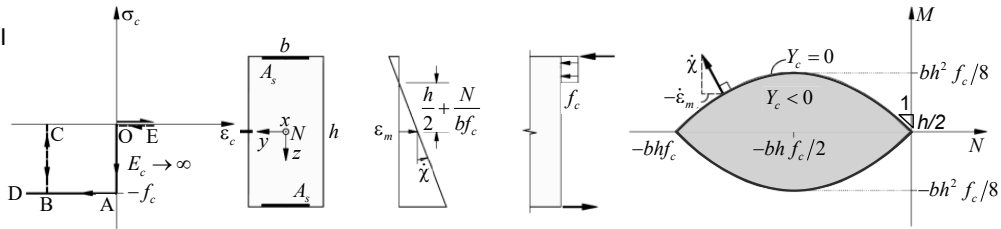

Compression zone (top):  $N_c = -\left(\frac{h}{2} - \frac{\dot{\epsilon}_m}{\dot{\chi}}\right)bf_c$ ,  $M_{yc} = -N_c\left(\frac{h}{2} + \frac{N_c}{2bf_c}\right)$  → Non-plastic domain  $Y_c < 0$ , limited by yield surface  $Y_c = 0$  (consists of two parabolas)

Compression zone (bottom):  $N_c = -\left(\frac{h}{2} + \frac{\dot{\epsilon}_m}{\dot{\chi}}\right)bf_c$ ,  $-M_{yc} = -N_c\left(\frac{h}{2} + \frac{N_c}{2bf_c}\right)$  → Plastic strain increments are orthogonal to the yield surface, directed outwards (associated flow rule, generally  $\dot{\epsilon} = \kappa \cdot \text{grad} Y$ )

Yield function:  $Y_c = \pm M_{yc} + N_c\left(\frac{h}{2} + \frac{N_c}{2bf_c}\right) = 0$

Yield law:  $\pm \frac{\dot{\epsilon}_m}{\dot{\chi}} = \frac{h}{2} + \frac{N_c}{bf_c} = \frac{\partial Y_c / \partial N_c}{\partial Y_c / \partial M_{yc}}$

Repetition Stahlbeton I (or Baustatik): Bending and normal force

## Repetition SBI - Interaction diagrams (M, N)

Rectangular cross-section - rigid-perfectly plastic behaviour, without concrete cover,  $A_s = A'_s$

(2) Reinforcement

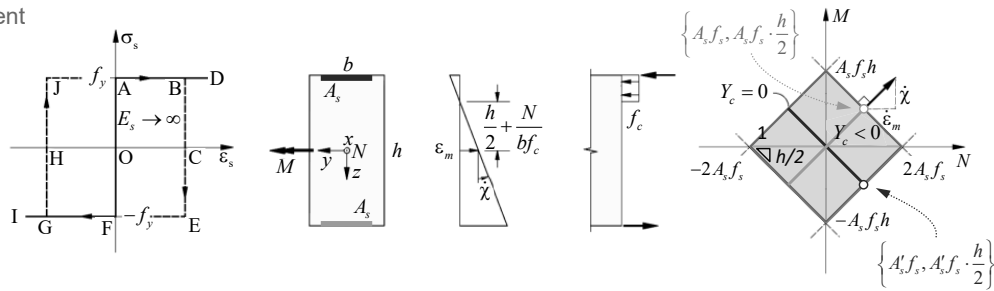

→ Non-plastic domain  $Y_s < 0$  for two reinforcement layers is a parallelogram (for symmetrical reinforcement  $A_s = A'_s$  → rhombus), which is defined by the vectors corresponding to the two reinforcement layers.

→ Graphical combination of the two reinforcement layers by geometric linear combination (see combination of concrete and reinforcement)

→ Corner points: both reinforcements yield, sides: one reinforcement yields

→ Plastic strain increments are orthogonal to the yield surface  $Y_s = 0$ , directed outwards (to the yield surface), i.e. gradients

Repetition Stahlbeton I (or Baustatik): Bending and normal force

## Repetition SBI - Interaction diagrams (M, N)

Rectangular cross-section - rigid-perfectly plastic behaviour, without concrete cover,  $A_s = A'_s$

(3) Reinforced concrete = concrete + reinforcement

- Yield surface of reinforced concrete obtained by geometric linear combination of the yield surfaces  $Y_c = 0$  and  $Y_s = 0$
- Procedure: Move the yield surface ( $Y_c = 0$ ) with its origin along yield surface ( $Y_s = 0$ ) (or vice versa  $Y_s = 0$  along  $Y_c = 0$ )
- Resulting area  $Y < 0$  corresponds to the non-plastic domain of the reinforced concrete cross-section, it is at least weakly convex, the associated flow rule (orthogonality of the plastic strain increments with respect to yield surface) still applies
- One reinforcement remains elastic (rigid) along the straight segments of the yield surface.
- Procedure transferable to any component and stresses

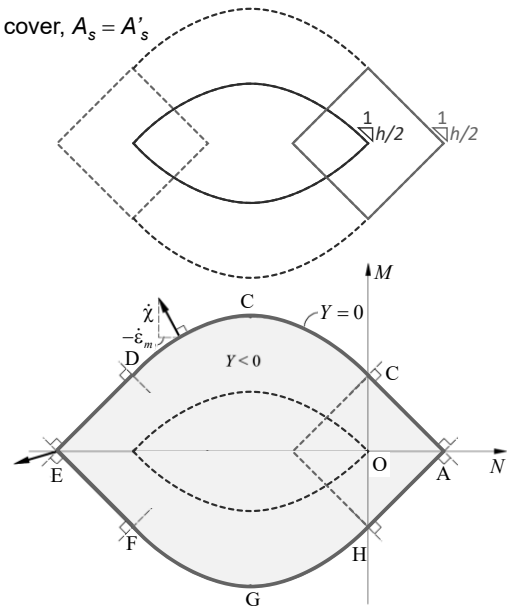

### Repetition Stahlbeton I (or Baustatik): Bending and normal force

- Interaction diagrams of reinforced concrete beams under bending and normal force can be determined for perfectly plastic behaviour by means of a graphical linear combination of the non-plastic domains of concrete and reinforcement.

# Membrane elements - Yield conditions

## Yield condition for orthogonally reinforced membrane elements

(«Reinforced concrete = concrete + reinforcement»):

Membrane thickness  $h$

Concrete and steel perfectly plastic, perfect (rigid) bond

Replace designations  $f_c$  and  $f_y$  (tension) or  $f'_y$  (compression) at design with  $f_c = k_c f_{cd}$  and  $f_y = -f'_y = f_{sd}$

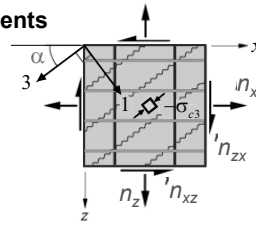

$$\begin{aligned} n_x &= n_{xc} + n_{xs} \\ &= n_{xc} + a_{sx} \sigma_{sx} \\ n_z &= n_{zc} + n_{zs} \\ &= n_{zc} + a_{sz} \sigma_{sz} \\ n_{xz} &= n_{xzc} \end{aligned}$$

Yield condition reinforcement:  
(absorbs only forces in its direction)

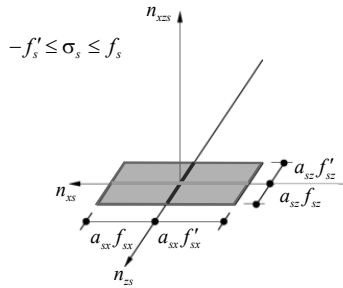

Yield condition concrete:  
(homogeneous, isotropic, with  $f_{ct} = 0$ )

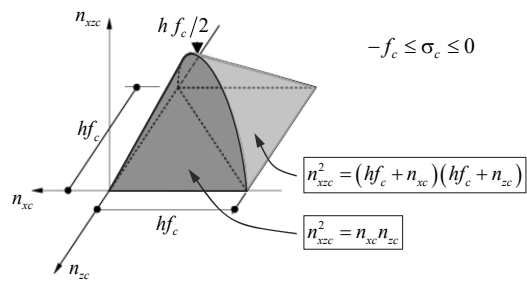

## Repetition Stahlbeton I: Yield conditions of orthogonally reinforced membrane elements:

- Yield conditions of orthogonally reinforced shear elements can be determined analogously to the interaction diagrams for bending and normal force by a graphical linear combination of the non-plastic domains of concrete and reinforcement.
- Non-plastic domain of orthogonal reinforcement: rectangle in the reinforcement plane  $n_{xz} = \tau_{xz} = 0$
- Non-plastic domain of the concrete: two elliptical cones (front  $\sigma_{c1} = 0$ , back  $\sigma_{c3} = -f_c$ )

# Membrane elements - Yield conditions

## Yield condition for orthogonally reinforced membrane elements

Geometric linear combination concrete + reinforcement

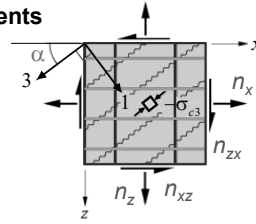
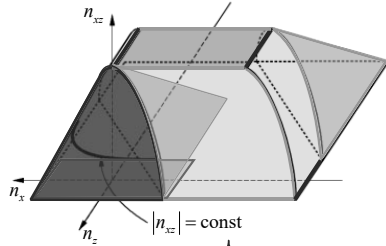

$$\begin{aligned} n_x &= n_{xc} + n_{xs} \\ &= n_{xc} + a_{sx} \sigma_{sx} \\ n_z &= n_{zc} + n_{zs} \\ &= n_{zc} + a_{sz} \sigma_{sz} \\ n_{xz} &= n_{xzc} \end{aligned}$$

**Procedure:**  
Move the yield surface  $Y_c = 0$  with its origin along yield surface  $Y_s = 0$  (or vice versa  $Y_s = 0$  along  $Y_c = 0$ )

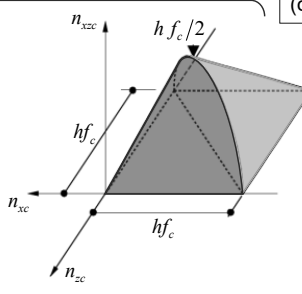
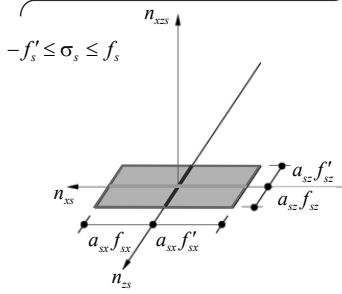

Repetition Stahlbeton I: Yield conditions of orthogonally reinforced membrane elements



## Membrane elements - Yield conditions

### Yield conditions / yield Regimes reinforced concrete

Linear combination of the yield conditions, i.e. shifting the yield condition of the concrete (origin) along the yield condition of the reinforcement.

«reinforced concrete = steel + concrete»

$$Y_1 = n_{xz}^2 - (a_{sx} f_{sx} - n_x)(a_{sz} f_{sz} - n_z) = 0$$

$$Y_2 = n_{xz}^2 - (hf_c - a_{sz} f_{sz} + n_z)(a_{sz} f_{sz} - n_z) = 0$$

$$Y_3 = n_{xz}^2 - (a_{sx} f_{sx} - n_x)(hf_c - a_{sx} f_{sx} + n_x) = 0$$

$$Y_4 = n_{xz}^2 - (hf_c / 2)^2 = 0$$

$$Y_5 = n_{xz}^2 + (a_{sx} f'_{sx} + n_x)(hf_c + a_{sx} f'_{sx} + n_x) = 0$$

$$Y_6 = n_{xz}^2 + (hf_c + a_{sz} f'_{sz} + n_z)(a_{sz} f'_{sz} + n_z) = 0$$

$$Y_7 = n_{xz}^2 - (hf_c + a_{sx} f'_{sx} + n_x)(hf_c + a_{sz} f'_{sz} + n_z) = 0$$

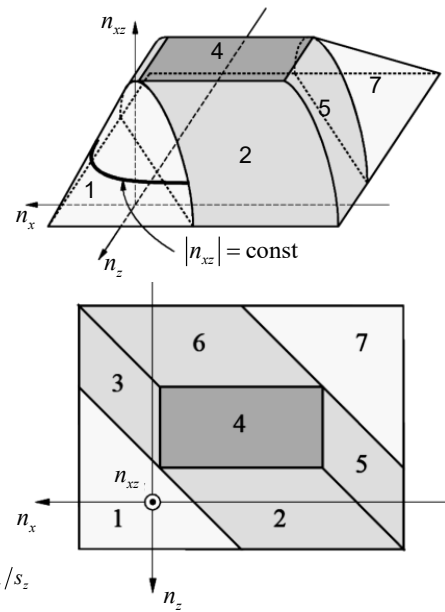

SN: Reinforcement areas per unit length in x- and z-direction  $a_{sx} = A_{sx}/s_x$   $a_{sz} = A_{sz}/s_z$

Repetition Stahlbeton I: Yield conditions of orthogonally reinforced membrane elements

## Membrane elements - Yield conditions

### Yield conditions / yield Regime Reinforced concrete

- Y<sub>1</sub>: Both reinforcements yield in tension  
 ( $\sigma_{sx} = f_{sx}, \sigma_{sz} = f_{sz}, 0 \geq \sigma_{c3} \geq -f_c$ )
- Y<sub>2</sub>: z-reinforcement yields in tension, concrete crushes  
 ( $\sigma_{sz} = f_{sz}, \sigma_{c3} = -f_c, -f'_{sx} \leq \sigma_{sx} \leq f_{sx}$ )
- Y<sub>3</sub>: x-reinforcement yields in tension, concrete crushes  
 ( $\sigma_{sx} = f_{sx}, \sigma_{c3} = -f_c, -f'_{sz} \leq \sigma_{sz} \leq f_{sz}$ )
- Y<sub>4</sub>: Concrete crushes  
 ( $\sigma_{c3} = -f_c, -f'_{sx} \leq \sigma_{sx} \leq f_{sx}, -f'_{sz} \leq \sigma_{sz} \leq f_{sz}$ )
- Y<sub>5</sub>: x-reinforcement yields in compression, concrete crushes  
 ( $\sigma_{sx} = -f'_{sx}, \sigma_{c3} = -f_c, -f'_{sz} \leq \sigma_{sz} \leq f_{sz}$ )
- Y<sub>6</sub>: z-reinforcement yields in compression, concrete crushes  
 ( $\sigma_{sz} = -f'_{sz}, \sigma_{c3} = -f_c, -f'_{sx} \leq \sigma_{sx} \leq f_{sx}$ )
- Y<sub>7</sub>: Both reinforcements yield in compression, concrete crushes  
 ( $\sigma_{sx} = -f'_{sx}, \sigma_{sz} = -f'_{sz}, \sigma_{c3} = -f_c$ )  
 (mean concrete principal stress also negative)

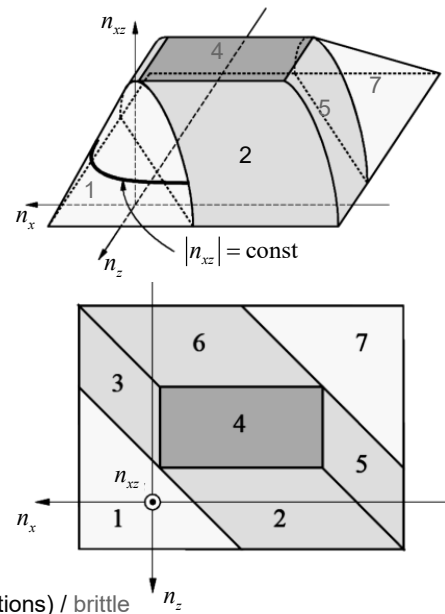

SN: failure type: very ductile / ductile (except for very flat stress field inclinations) / brittle

Repetition Stahlbeton I: Yield conditions of orthogonally reinforced membrane elements

## Membrane elements - Yield conditions

### Strain increments and principal compressive direction

Strain increments are proportional to the components of the outer normal to the yield surface (gradient) in the respective point of the yield surface ( $\kappa \geq 0$ : any factor):

$$\dot{\epsilon}_x = \kappa \frac{\partial Y}{\partial n_x}, \quad \dot{\epsilon}_z = \kappa \frac{\partial Y}{\partial n_z}, \quad \dot{\gamma}_{xz} = \kappa \frac{\partial Y}{\partial n_{xz}}$$

Inclination  $\alpha$  of the principal compressive direction 3 with respect to the x-axis follows from the Mohr's circle of plastic strain increments (principal strain direction = principal compressive direction in concrete):

$$\cot 2\alpha = \frac{\dot{\epsilon}_z - \dot{\epsilon}_x}{\dot{\gamma}_{xz}} \quad \text{mit} \quad \cot \alpha = \frac{\cos(2\alpha) + 1}{\sin(2\alpha)} = \cot(2\alpha) + \sqrt{\frac{\cos^2(2\alpha) + \sin^2(2\alpha)}{\sin^2(2\alpha)}}$$

$$\cot \alpha = \frac{\dot{\epsilon}_z - \dot{\epsilon}_x}{\dot{\gamma}_{xz}} + \sqrt{\left(\frac{\dot{\epsilon}_z - \dot{\epsilon}_x}{\dot{\gamma}_{xz}}\right)^2 + 1}$$

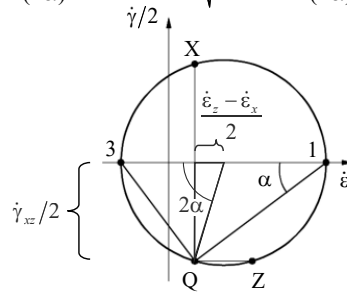

$$\left. \begin{aligned} Y_1 : \cot^2 \alpha &= (a_{sx} f_{sx} - n_x) / (a_{sz} f_{sz} - n_z) \\ Y_2 : \cot^2 \alpha &= (h f_c - a_{sz} f_{sz} + n_z) / (a_{sz} f_{sz} - n_z) \\ Y_3 : \cot^2 \alpha &= (a_{sx} f_{sx} - n_x) / (h f_c - a_{sx} f_{sx} + n_x) \\ Y_4 : \cot^2 \alpha &= 1 \\ Y_5 : \cot^2 \alpha &= -(a_{sx} f'_{sx} + n_x) / (h f_c + a_{sx} f'_{sx} + n_x) \\ Y_6 : \cot^2 \alpha &= -(h f_c + a_{sz} f'_{sz} + n_z) / (a_{sz} f'_{sz} + n_z) \\ Y_7 : \cot^2 \alpha &= -(h f_c + a_{sx} f'_{sx} + n_x) / (h f_c + a_{sz} f'_{sz} + n_z) \end{aligned} \right\}$$

Repetition Stahlbeton I: Yield conditions of orthogonally reinforced membrane elements

## Membrane elements - Yield conditions

### Dimensioning of reinforcement

Design practice: Usually Regime 1 (ductile failure type; both reinforcements yield before concrete crushing, concrete remains "elastic" = undamaged).

Yield condition for Regime 1 in parametric form (→ direct dimensioning):

$$Y_1 = n_{xz}^2 - (a_{sx} f_{sx} - n_x)(a_{sz} f_{sz} - n_z) = 0$$

$$k = \cot \alpha \rightarrow \begin{aligned} a_{sx} f_{sx} &\geq n_x + k |n_{xz}| \\ a_{sz} f_{sz} &\geq n_z + k^{-1} |n_{xz}| \end{aligned}$$

Yield condition in Regime 1 is governing (no concrete crushing) if:

$$h f_c \geq a_{sx} f_{sx} + a_{sz} f_{sz} - (n_x + n_z)$$

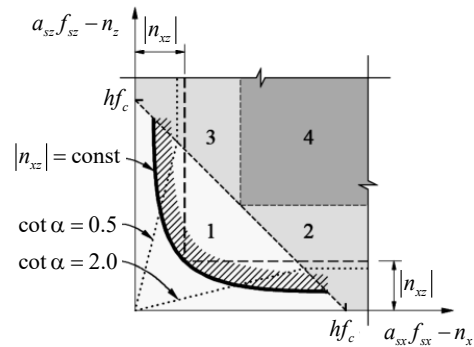

SN:

→ Value of  $f_c$  see next chapter. Approximation according to SIA 262:  $f_c = k_c f_{cd}$  (with  $k_c = 0.55$ )

→ Inclination of the concrete stress field in Regime 1 follows from:  $\cot^2 \alpha = (a_{sx} f_{sx} - n_x) / (a_{sz} f_{sz} - n_z)$

→ Value  $k = \cot \alpha$  can theoretically be freely chosen, in design standards often limited by the condition  $0.5 \leq k \leq 2$

→ Use of  $k = 1$ , i.e.  $\alpha = 45^\circ$ : "linearised yield conditions", implemented in many FE programs. Safe dimensioning, but this is just one of many possibilities (possibly strongly on the safe side)

Repetition Stahlbeton I: Design of orthogonally reinforced membrane elements in Regime 1

## Membrane elements - Yield conditions

### Web crushing (Regime 2)

If the condition  $hf_c \geq a_{sx}f_{sx} + a_{sz}f_{sz} - (n_x + n_z)$  is not satisfied, a failure type where the concrete fails under compression (crushes) is governing.

Regime 2 is also of particular practical relevance. It applies if the condition  $a_{sx}f_{sx} - n_x > a_{sz}f_{sz} - n_z$  is met.

- Type of failure: Yielding of the z-reinforcement with simultaneous concrete compressive failure, called *web crushing*.
- The corresponding limitation of the shear resistance of the membrane element can be represented as a quarter circle.
- Limitations for  $\cot \alpha$  correspond to straight lines in the diagram

SN: Figure on the right = projection of the yield surface to the plane  $(n_x, n_z)$ , shifted by  $a_{sz}f_{sz}$  ( $n_x$  = generalised reaction)

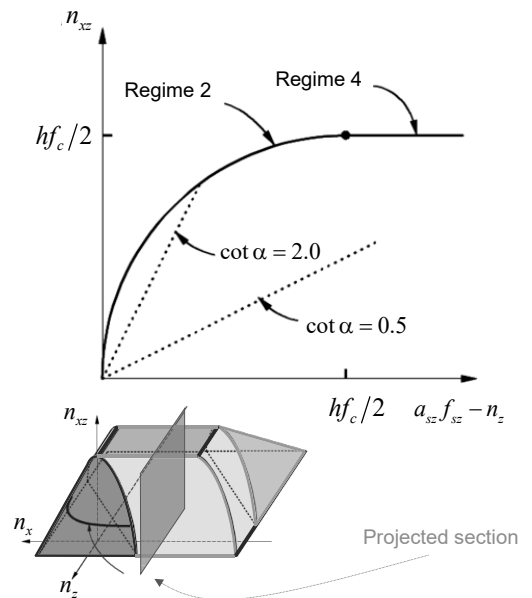

Repetition Stahlbeton I: Design of orthogonally reinforced membrane elements in Regime 2

## Membrane elements - Yield conditions

### Skew reinforcements

Calculation of the equivalent orthogonal reinforcement (representation with Mohr's circles)

$$\sigma_{1s,3s} = \frac{1}{2} \left[ \sum_{k=1}^m \rho_k f_{syk} \pm \sqrt{\left( \sum_{k=1}^m \rho_k f_{syk} \cos(2\psi_k) \right)^2 + \left( \sum_{k=1}^m \rho_k f_{syk} \sin(2\psi_k) \right)^2} \right]$$

$$\tan(2\varphi_s) = \frac{\sum_{k=1}^m \rho_k f_{syk} \sin(2\psi_k)}{\sum_{k=1}^m \rho_k f_{syk} \cos(2\psi_k)}$$

(see dissertation Seelhofer, 2009)

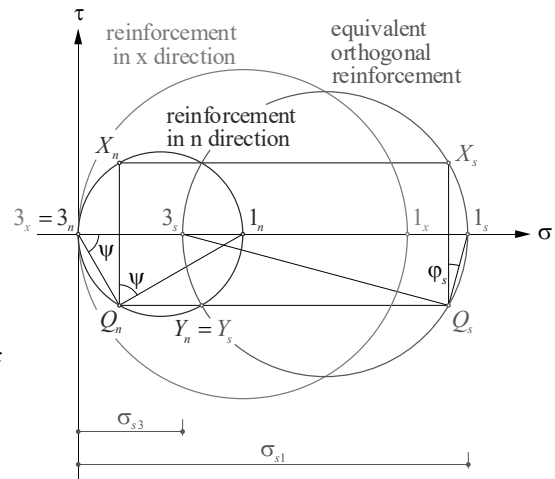
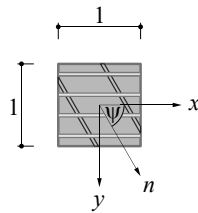

The following slides show how skew reinforcements can be designed and how the corresponding yield conditions can be determined [Seelhofer (2009)]. By the term “skew reinforcement”, we refer here to oblique reinforcement directions (as opposed to orthogonal reinforcement), and NOT to orthogonal reinforcement simply rotated with respect to the coordinate axes, as sometimes called “skew reinforcement” in literature.

The membrane element is reinforced in the x- and n-direction whereby the n-direction crosses the x-direction at an angle  $\psi$ .

The equivalent orthogonal reinforcement can be calculated or determined graphically (see next slides).

# Membrane elements - Yield conditions

## Skew reinforcements

Graphical determination of the equivalent orthogonal reinforcement

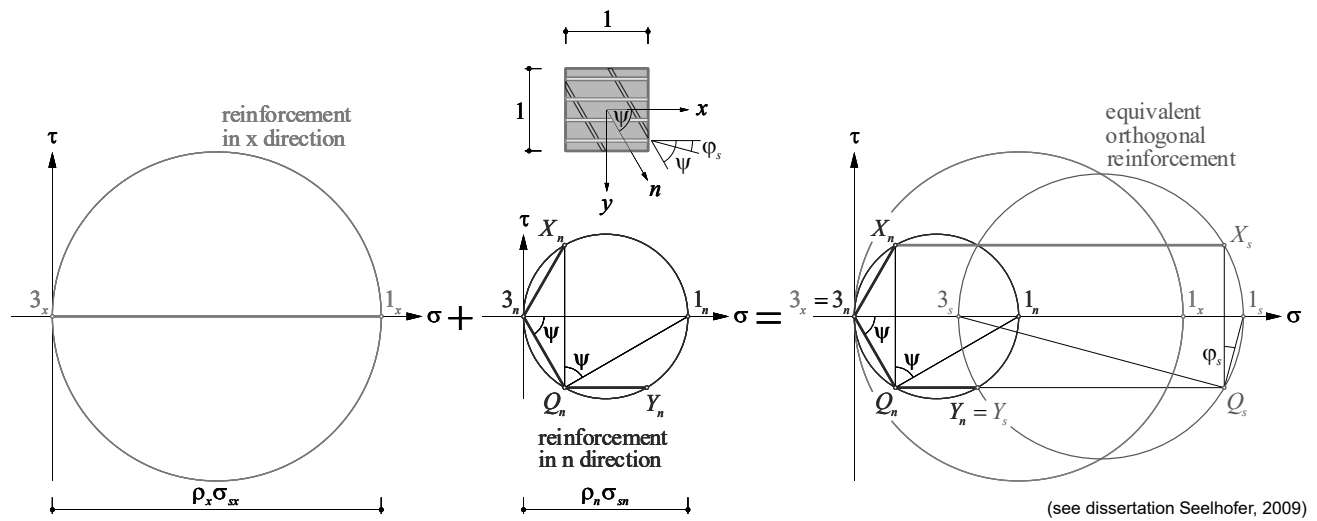

To obtain the equivalent orthogonal reinforcement, the reinforcements in x- and n-direction are superimposed. In contrast to the reinforcement in x-direction, the inclined reinforcement (n-direction) has a shear component.

The angle  $\phi_s$  shows the inclination of the equivalent orthogonal reinforcement with respect to the x-direction.

# Membrane elements - Yield conditions

## Skew reinforcements

Graphical determination of the equivalent orthogonal reinforcement

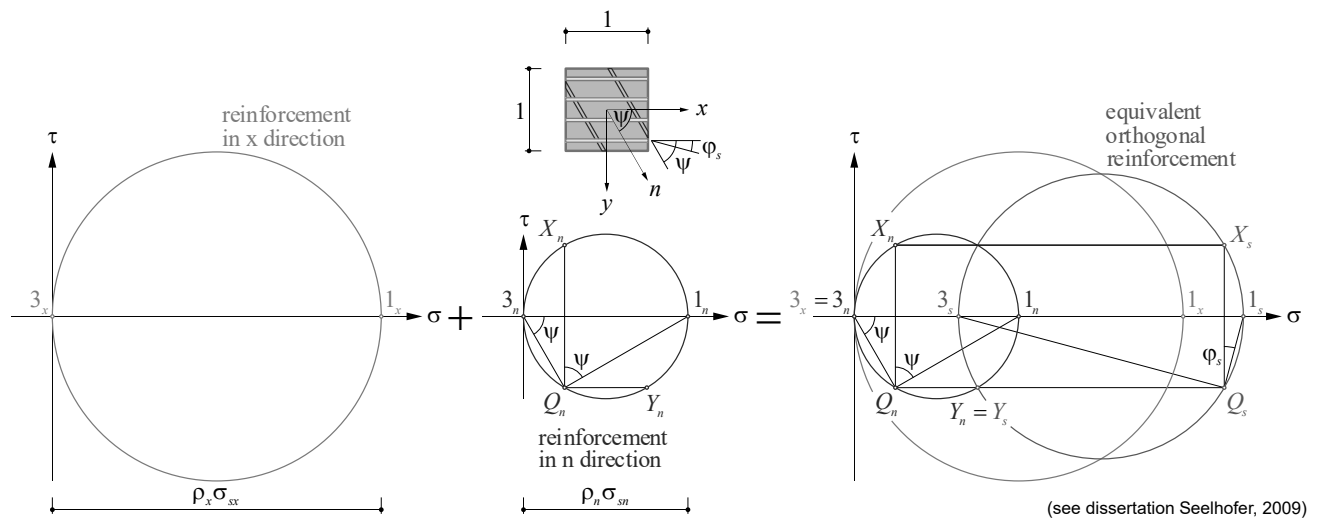

To obtain the equivalent orthogonal reinforcement, the reinforcements in x- and n-direction are superimposed. In contrast to the reinforcement in x-direction, the inclined reinforcement (n-direction) has a shear component.

The angle  $\varphi_s$  shows the inclination of the equivalent orthogonal reinforcement with respect to the x-direction.



# Membrane elements - Yield conditions

## Skew reinforcements

Equilibrium («applied stress = concrete + reinforcement»)

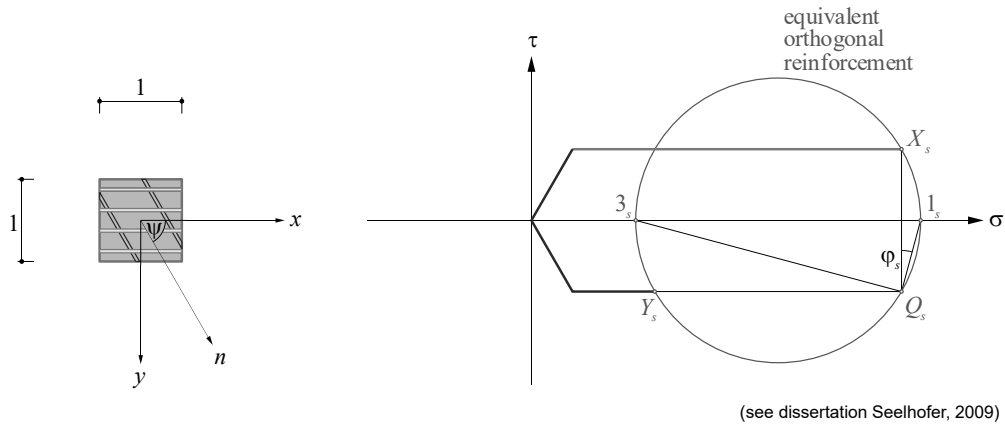

The stress state of the concrete and the reinforcement are in equilibrium with the applied stresses.

The membrane element with skew reinforcement must withstand less shear stress in the concrete compared to an orthogonally reinforced membrane element.

# Membrane elements - Yield conditions

## Skew reinforcements

Equilibrium («applied stress = concrete + reinforcement»)

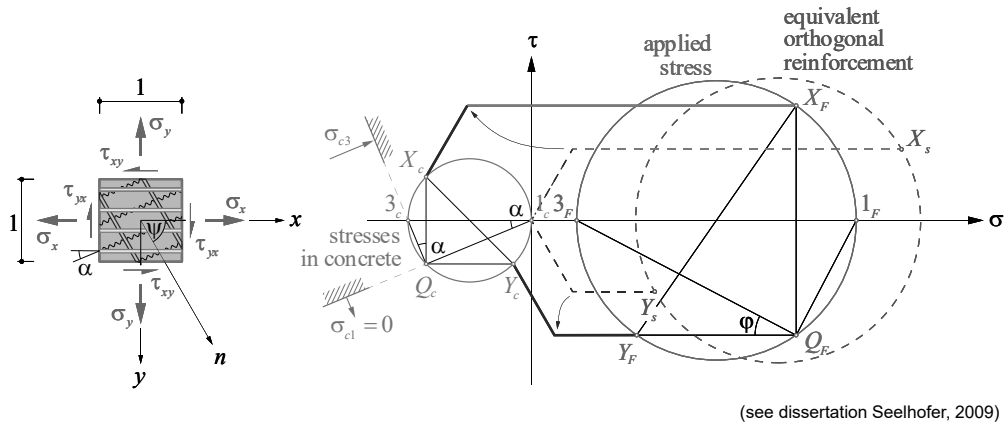

The stress state of the concrete and the reinforcement are in equilibrium with the applied stresses.

The membrane element with skew reinforcement must withstand less shear stress in the concrete compared to an orthogonally reinforced membrane element.

## Membrane elements - Yield conditions

### Skew reinforcements

With skew reinforcements, the determination of the yield conditions becomes mathematically significantly more complicated. For Regime 1, for example, the yield condition becomes:

$$Y_1 = \left( \tau_{xy} - \rho_n f_{sn} \sin \psi \cos \psi \right)^2 - \underbrace{\left( \rho_x f_{sx} + \rho_n f_{sn} \cos^2 \psi - \sigma_x \right)}_{\geq 0} \underbrace{\left( \rho_n f_{sn} \sin^2 \psi - \sigma_y \right)}_{\geq 0} = 0$$

With loads transformed to skew coordinates, the relationships for the direct design of the reinforcement in Regime 1 follow from:

$$k = |\cos \psi + \sin \psi \cot \theta|$$

$$\rho_x f_{sx} \geq \frac{1}{\sin \psi} \left( \sigma_\xi + k |\tau_{\xi\eta}| \right) \quad \rho_n f_{sn} \geq \frac{1}{\sin \psi} \left( \sigma_\eta + k^{-1} |\tau_{\xi\eta}| \right)$$

and for checking the concrete compressive strength:

$$\sigma_{c3} = \frac{1}{\sin \psi} \left[ 2\tau_{\xi\eta} \cos \psi - |\tau_{\xi\eta}| (k + k^{-1}) \right] \geq -f_c$$

$$\sigma_\xi = \sigma_x \sin \psi + \sigma_y \cos \psi \cot \psi - 2\tau_{xy} \cos \psi$$

$$\sigma_\eta = \frac{\sigma_y}{\sin \psi}$$

$$\tau_{\xi\eta} = \tau_{\eta\xi} = \tau_{xy} - \sigma_y \cot \psi$$

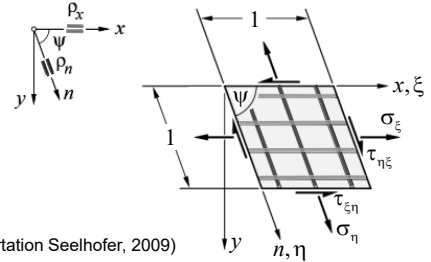

(see dissertation Seelhofer, 2009)

The relationships are more complicated than for orthogonal reinforcement, since the reinforcement inclined with respect to the  $(x, y)$ -axes bears part of the shear loads  $n_{xz}$  (unlike orthogonal reinforcement, for which  $n_{xzs} = 0$ ).

If the stress is transformed using skew coordinates (in the direction of reinforcement), the design can be performed in the same way as for orthogonal reinforcement (direct dimensioning). For the sake of simplicity, the coordinate axes are selected so that one reinforcement direction runs in the  $x$ -direction.

The given relationships were derived from Seelhofer and Marti and are much more practical than older "design algorithms" for skew reinforcements, as they are implemented in FE programs today (in the case they allow a design of skew reinforcements at all).

# Membrane elements - Yield conditions

## Skew reinforcements

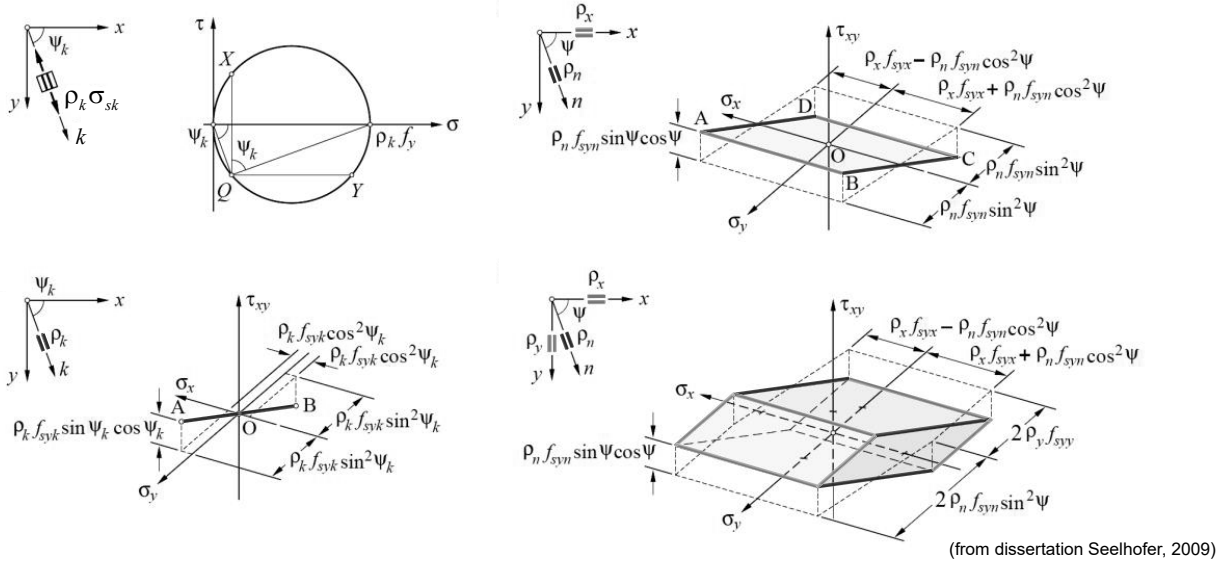

Similarly to orthogonal reinforcement, the yield conditions of membrane elements reinforced in a number of arbitrary directions can also be determined by a graphical linear combination of the non-plastic zones of concrete and reinforcement.

The non-plastic domain of each reinforcement layer is a straight line. While these straight lines are parallel to the coordinate axes for reinforcements in the coordinate directions (here:  $x$ -reinforcement), they are inclined for skew reinforcement. They are neither in the plane,  $n_{xz} = \tau_{xz} = 0$ , nor are their projections into this plane parallel to one of the coordinate axes. The corner points of a reinforcement inclined by the angle  $\psi_k$  with respect to the  $x$ -axis are defined by the membrane forces  $\{n_x, n_z, n_{xz}\}_{sk} = \{a_{sk} \cdot f_{sk} \cdot \cos^2 \psi_k, a_{sk} \cdot f_{sk} \cdot \sin^2 \psi_k, a_{sk} \cdot f_{sk} \cdot \sin \psi_k \cdot \cos \psi_k\}$  corresponding to its tensile yield force  $a_{sk} \cdot f_{sk}$  or by the equivalent stresses  $\{\rho_k \cdot f_{sk} \cdot \cos^2 \psi_k, \rho_k \cdot f_{sk} \cdot \sin^2 \psi_k, \rho_k \cdot f_{sk} \cdot \sin \psi_k \cdot \cos \psi_k\}$  (see bottom left figure).

These two straight lines of the reinforcements in direction  $x$  and  $k$  can be combined to a parallelogram which lies in the plane defined by the two straight lines (see top right figure).

With three inclined reinforcement layers, the non-plastic domain of the reinforcement corresponds to a parallelepiped (see bottom right figure). For even more reinforcement directions, the yield surface can be constructed as a graphical linear combination of the yield figures of the individual reinforcement layers.

(continued on the following slide)

## Membrane elements - Yield conditions

### Skew reinforcements

- Two oblique = skew reinforcement layers: flat, parallelogram-shaped yield figure of the reinforcement, inclined relative to the  $\sigma_{sx}$ - $\sigma_{sy}$ -plane.
- Three oblique = skew reinforcement layers: Parallelepiped, can carry load without concrete (imagine a hinged connection of reinforcing bars)
- Yield surface of a reinforced concrete membrane element results from translation of the concrete yield surface with its origin on the yield surface of the reinforcement (geometric linear combination)

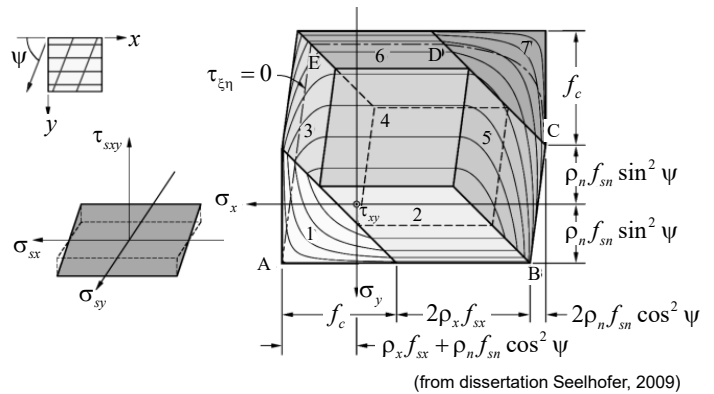

Alternatively,  $n$  inclined reinforcements can be transformed to the orthogonal  $x$ - $z$  coordinate system to determine an equivalent orthogonal reinforcement. The yield conditions of the orthogonal reinforcement can then be used, whereby the applied stress is to be transformed into the direction of the equivalent orthogonal reinforcement.

(see dissertation Seelhofer, 2009)

$$\sigma_{sx} = \sum_i \sigma_{si} \cos^2 \psi_i \quad \sigma_{s1,2} = \sum_i \sigma_{si} \cos^2 \psi_i \frac{\sigma_{sx} + \sigma_{sz}}{2} \pm \frac{\sqrt{(\sigma_{sx} - \sigma_{sy})^2 + 4\tau_{sxy}^2}}{2}$$

$$\sigma_{sy} = \sum_i \sigma_{si} \sin^2 \psi_i \quad \varphi_{s1} = \frac{1}{2} \tan^{-1} \left( \frac{2\tau_{sxy}}{\sigma_{sx} - \sigma_{sz}} \right)$$

$$\tau_{sxy} = \sum_i \sigma_{si} \sin \psi_i \cos \psi_i$$

13.10.2021

ETH Zurich | Chair of Concrete Structures and Bridge Design | Advanced Structural Concrete

29

As with orthogonal reinforcement, the non-plastic domain of the concrete consists of two elliptical cones (front  $\sigma_{c1} = 0$ , rear  $\sigma_{c3} = -f_c$ ). Combining the non-plastic domains of concrete and reinforcement results in the yield surface of the inclined = skew reinforced membrane element (see figure above).

Alternatively, skew reinforcements can be replaced by an equivalent orthogonal reinforcement. Assuming a constant stress state in the reinforcement (i.e., yielding), the stress state can be transformed to the  $x$ - $z$  coordinate system, even for a reinforcement mesh consisting of any number of non-orthogonal reinforcement layers (see equations in the figure).

The equivalent steel stresses of the equivalent orthogonal reinforcement then correspond to the principal stresses ( $\sigma_{s1}$ ,  $\sigma_{s2}$ ) of the stress state defined by ( $\sigma_{sx}$ ,  $\sigma_{sy}$ ,  $\tau_{sxy}$ ). The directions of the equivalent orthogonal reinforcement correspond to the associated principal directions (1, 2).

For the equivalent orthogonal reinforcement, the yield conditions for orthogonal reinforcement can be applied. For the verifications, the loads shall be transformed into the directions (1, 2) of the reinforcement.

# Membrane elements - Yield conditions

## Summary

- «Reinforced concrete = steel + concrete»
- Well suited for design on the basis of FE calculations (limit values)
- Dimensioning for Regime 1, verification of the prerequisites (no concrete crushing, compressive strength, see compability and deformation capacity)
- Safe design possible with linearised yield conditions
- Regime 2 important for beams, "web crushing failure".
- Skew reinforcements can be treated in the same way (but mathematically more complicated)

